

IMB-146

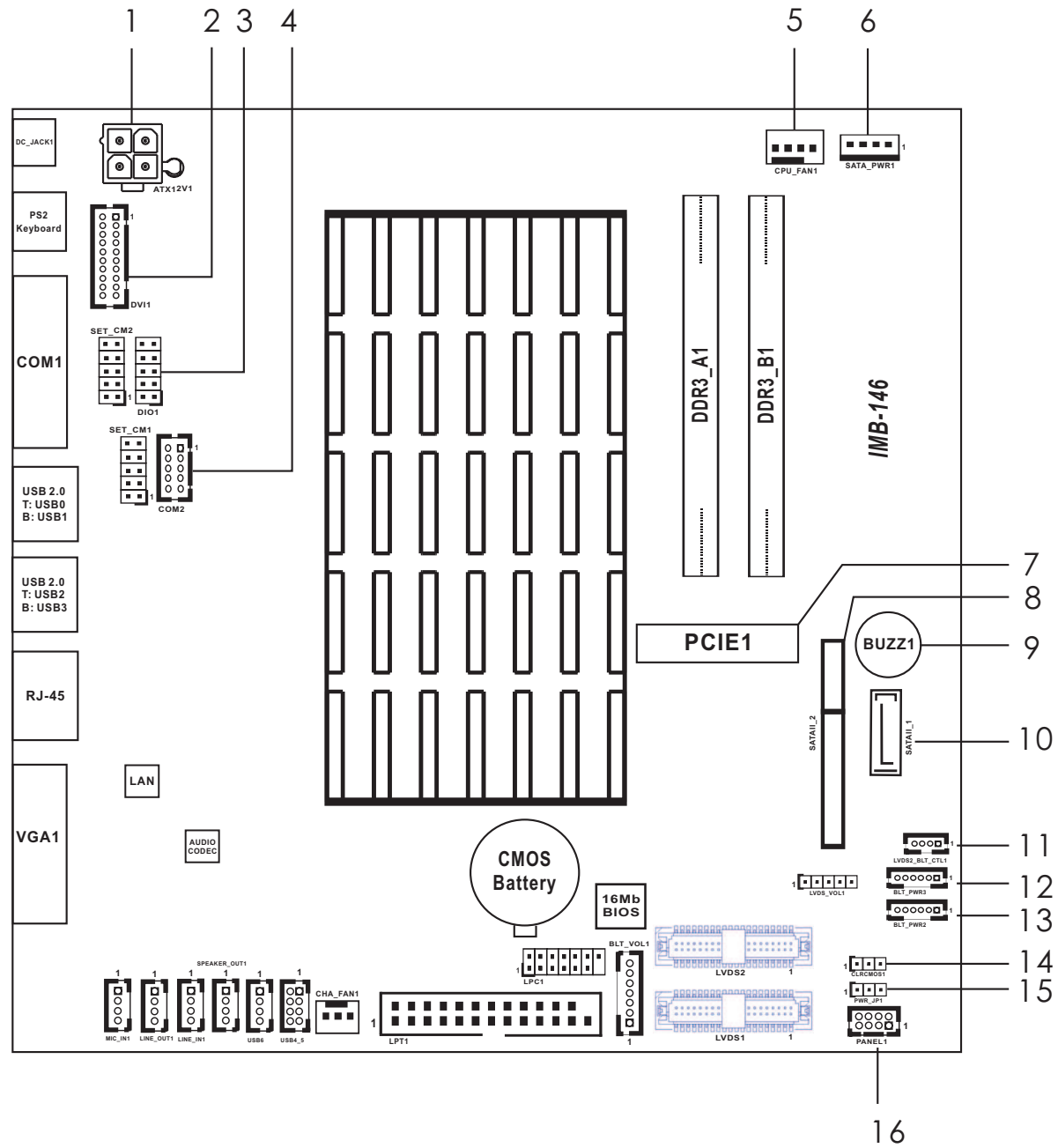

1 : ATX 12V Power Connector



2 : DVI Connector

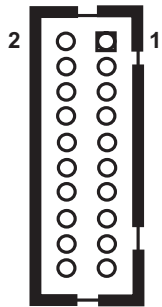

PIN	Signal Name	PIN	Signal Name
2	NC	1	GND
4	GND	3	TMDS CLK-
6	TMDS DATA1+	5	TMDS CLK+
8	TMDS DATA1-	7	GND
10	GND	9	GND
12	DDC DATA	11	TMDS DATA0+
14	DDC CLK	13	TMDS DATA0-
16	GND	15	GND
18	TMDS DATA2+	17	HOT PLUG
20	TMDS DATA2-	19	+5V

3 : Digital I/O Header
GPIO from Super I/O

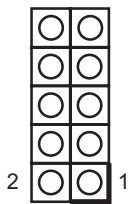

PIN	Signal Name	PIN	Signal Name
10	GND	9	+5V
8	SIO_GP03	7	SIO_GP07
6	SIO_GP02	5	SIO_GP06
4	SIO_GP01	3	SIO_GP05
2	SIO_GP00	1	SIO_GP04

Super I/O: Nuvoton NCT6776D

4 : COM Port Header

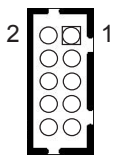

PIN	Signal Name	PIN	Signal Name
2	NC	1	GND
4	COM PWR/RI	3	DTR
6	CTS	5	TXD
8	RTS	7	RXD
10	DSR	9	COM PWR/DCD

5 : 4-Pin CPU FAN Connector (+12V)
6 : SATA Power Output Connector

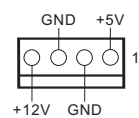

7 : mini PCIE Connector (Half size only)
8,10 : SATA2 Connectors
9 : Buzzer

11 : LVDS2 Backlight Control Connector



PIN	Signal Name
1	GND
2	BL DW
3	BL UP
4	LVDS2 EN

Backlight Power Connectors
12 : BLT_PWR2 (for LVDS1)
13 : BLT_PWR3 (for LVDS2)



PIN	Signal Name
1	+12V
2	+12V
3	BL EN
4	BL CTL
5	GND
6	GND

14 : Clear CMOS Header
1-2: Normal (Default)
2-3: Clear CMOS

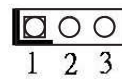

15 : PWR_JP Header
1-2: AT Mode
2-3: ATX Mode (Default)

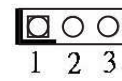

16 : System Panel Header

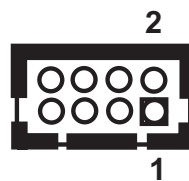

PIN	Signal Name	PIN	Signal Name
1	GND	2	RESET#
3	GND	4	PWRBTN#
5	HDLED+	6	HDLED-
7	PLED+	8	SUS LED

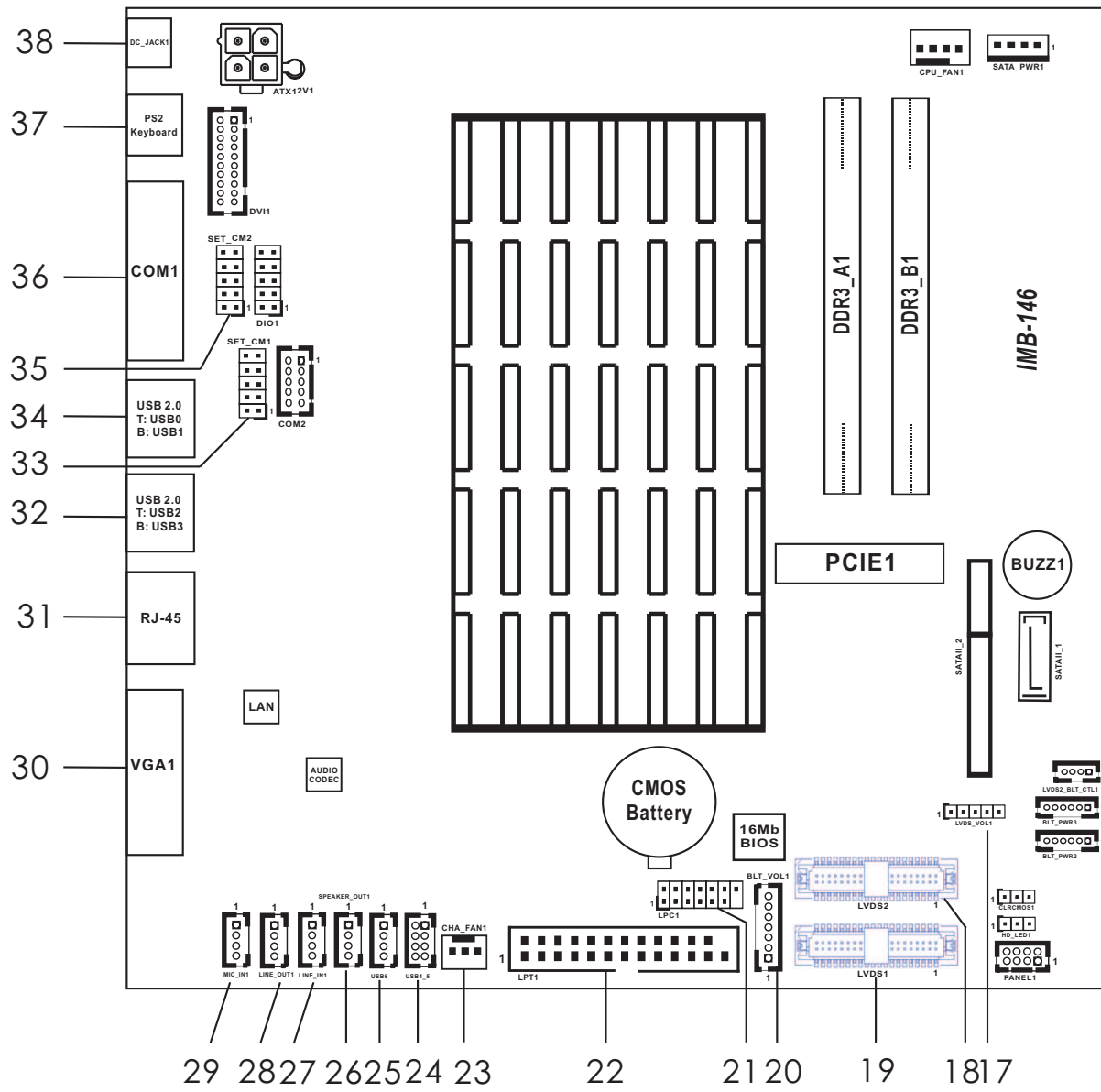

17 : LVDS Power Jumper



PIN	Signal Name
1	+3V
2	LVDS VDD
3	+5V
4	LVDS VDD
5	+12V

21 : LPC Debug Header

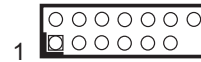

PIN	Signal Name	PIN	Signal Name
14	+3V	13	NC
12	+3V	11	+3V
10	GND	9	GND
8	LAD3	7	LAD2
6	LAD1	5	LAD0
4	LFRAME#	3	RESET#
2	GND	1	CLK

LVDS Panel Connectors

18 : LVDS2

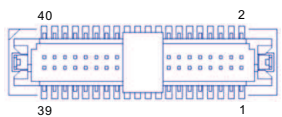

19 : LVDS1

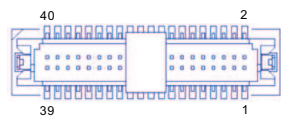

PIN	Signal Name	PIN	Signal Name
39	GND	40	GND
37	NC	38	NC
35	NC	36	NC
33	NC	34	NC
31	NC	32	NC
29	NC	30	NC
27	GND	28	GND
25	LVDS2 D3(-)	26	LVDS2 D3(+)
23	LVDS2 CLK(-)	24	LVDS2 CLK(+)
21	LVDS2 D2(-)	22	LVDS2 D2(+)
19	LVDS2 D1(-)	20	LVDS2 D1(+)
17	LVDS2 D0(-)	18	LVDS2 D0(+)
15	B/L ENABLE	16	GND
13	B/L ADJUST	14	LVDS PWR EN
11	NC	12	NC
9	LVDS PWR	10	LVDS PWR
7	VCC 3.3V	8	GND
5	+12V	6	GND
3	+12V	4	+12V
1	+12V	2	+12V

PIN	Signal Name	PIN	Signal Name
39	GND	40	GND
37	LVDS1 D3(-)	38	LVDS1 D3(+)
35	LVDS1 CLK(-)	36	LVDS1 CLK(+)
33	LVDS1 D2(-)	34	LVDS1 D2(+)
31	LVDS1 D1(-)	32	LVDS1 D1(+)
29	LVDS1 D0(-)	30	LVDS1 D0(+)
27	GND	28	GND
25	LVDS1 D3(-)	26	LVDS1 D3(+)
23	LVDS1 CLK(-)	24	LVDS1 CLK(+)
21	LVDS1 D2(-)	22	LVDS1 D2(+)
19	LVDS1 D1(-)	20	LVDS1 D1(+)
17	LVDS1 D0(-)	18	LVDS1 D0(+)
15	B/L ENABLE	16	GND
13	B/L ADJUST	14	LVDS PWR EN
11	DDC CLK	12	DDC DATA
9	LVDS PWR	10	LVDS PWR
7	VCC 3.3V	8	GND
5	+12V	6	GND
3	+12V	4	+12V
1	+12V	2	+12V

22 : Printer Port Header

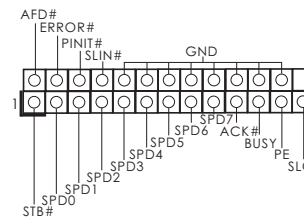

23 : 3-Pin Chassis FAN Connector (+12V)

Internal USB Connectors

24 : USB Port 4,5

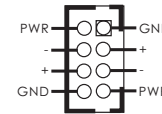

25 : USB Port 6



26 : Speaker-Out Connector

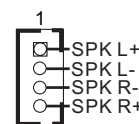

27 : Line-In Connector

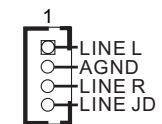

28 : Line-Out Connector

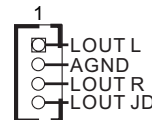

29 : Mic-In Connector

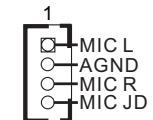

20 : Backlight & Amp Volume Control Header



PIN	Signal Name
1	PWRBTN
2	VOL UP
3	VOL DW
4	BL UP
5	BL DW
6	GND
7	PWR LED

30 : VGA Port

31 : RJ-45 LAN Port

32 : USB 2.0 Ports (USB23)

COM PWR Setting Jumpers

33 : SET_CM1

35 : SET_CM2



PIN	Signal Name	PIN	Signal Name
10	RRI#	9	DDCD#
8	P9	7	P1
6	+5VIO	5	+5VIO
4	P9	3	P1
2	+12VIO	1	+12VIO

34 : USB 2.0 Ports (USB01)

36 : Serial Port: COM1

37 : PS/2 Keyboard/Mouse Combo

38 : +12V DC-In Jack