

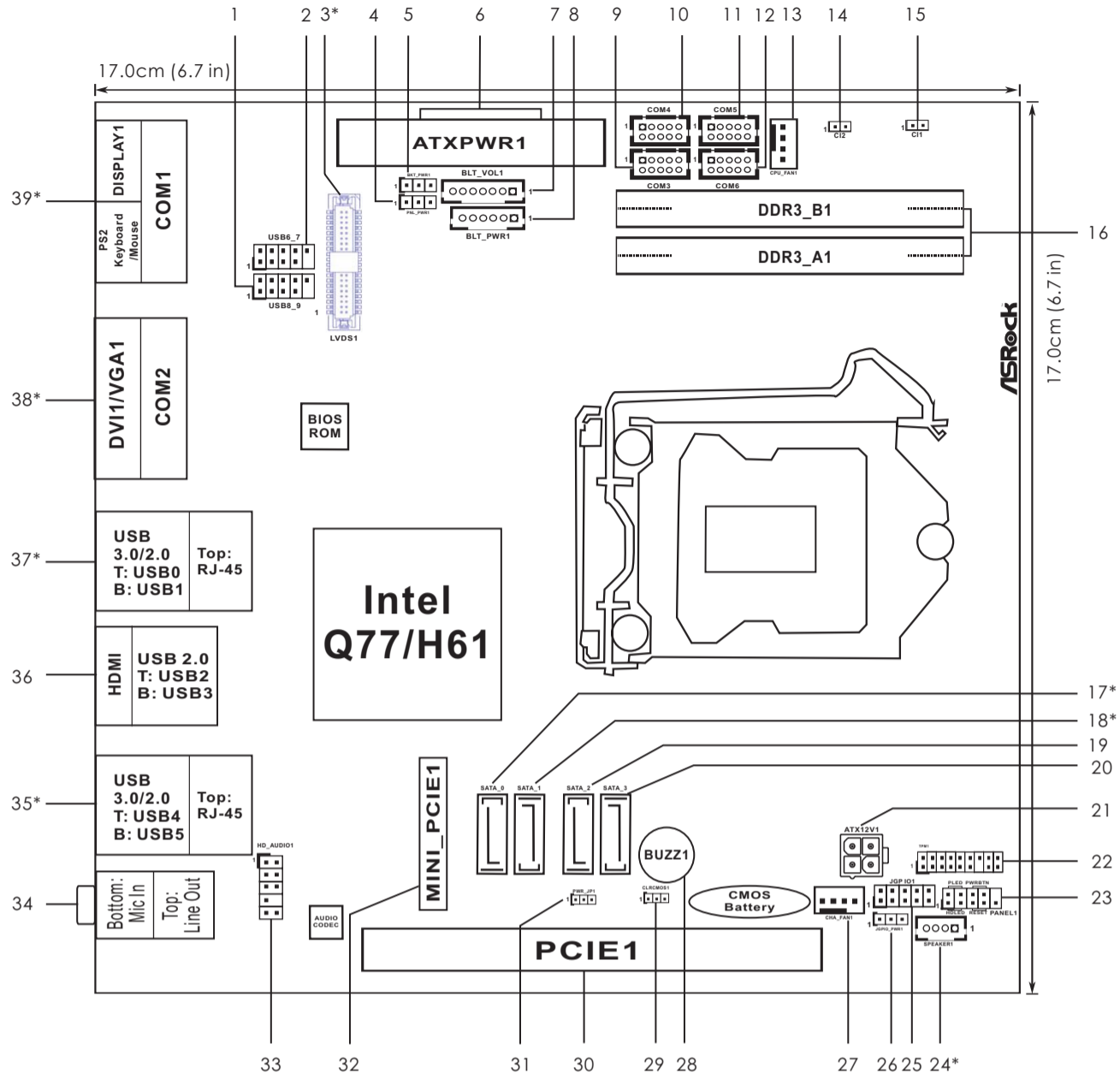

ASRock Jumpers and headers setting guide

IMB-171-D IMB-171-L IMB-161-D IMB-161-L

The terms HDMI™ and HDMI High-Definition Multimedia Interface, and the HDMI logo are trademarks or registered trademarks of HDMI Licensing LLC in the United States and other countries.



1 : USB2.0 Header (USB8_9)
2 : USB2.0 Header (USB6_7)

3* : LVDS Panel Connector
(For IMB-171-L and IMB-161-L only)

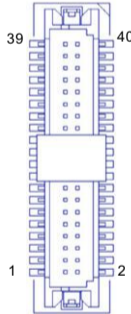

PIN	Signal Name	PIN	Signal Name
2	LCD_VCC	1	LCD_VCC
4	LDDC_CLK	3	+3V
6	LVDS_A_DATA0#	5	LDDC_DATA
8	GND	7	LVDS_A_DATA0
10	LVDS_A_DATA1	9	LVDS_A_DATA1#
12	LVDS_A_DATA2#	11	GND
14	GND	13	LVDS_A_DATA2
16	LVDS_A_DATA3	15	LVDS_A_DATA3#
18	LVDS_A_CLK#	17	GND
20	GND	19	LVDS_A_CLK
22	LVDS_B_DATA0	21	LVDS_B_DATA0#
24	LVDS_B_DATA1#	23	GND
26	GND	25	LVDS_B_DATA1
28	LVDS_B_DATA2	27	LVDS_B_DATA2#
30	LVDS_B_DATA3#	29	DPLVDD_EN
32	GND	31	LVDS_B_DATA3
34	LVDS_B_CLK	33	LVDS_B_CLK#
36	CON_LBKLT_EN	35	GND
38	LCD_BLT_VCC	37	CON_LBKLT_CTL
40	LCD_BLT_VCC	39	LCD_BLT_VCC

4 : Panel Power Selection (LCD_VCC)
1-2 : +3V
2-3 : +5V

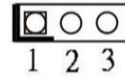

5 : Backlight Power Selection (LCD_BLT_VCC)
1-2 : +5V
2-3 : +12V

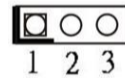

6 : 24-pin ATX Power Input Connector

7 : Backlight & Amp Volume Control



PIN	Signal Name
1	GPIO_VOL_UP
2	GPIO_VOL_DW
3	PWRDN
4	GPIO_BLT_UP
5	GPIO_BLT_DW
6	GND
7	GND

8 : Inverter Power control Wafer



PIN	Signal Name
1	GND
2	GND
3	CON_LBKLT_CTL
4	CON_LBKLT_EN
5	LCD_BLT_VCC
6	LCD_BLT_VCC

COM Port Headers

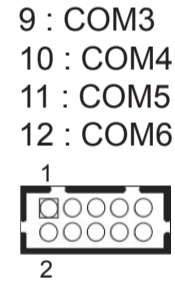

PIN	Signal Name	PIN	Signal Name
2	RRXD1	1	DDCD#1
4	DDTR#1	3	TTXD1
6	DDSR#1	5	GND
8	CCTS#1	7	RRTS#1
10	NC	9	COM PWR

13 : 4-Pin CPU FAN Connector (+12V)

14 : Chassis Intrusion Header 2
15 : Chassis Intrusion Header 1



16 : 2 x SO-DIMM

17,18* : IMB-171-D/IMB-171-L: SATA3
IMB-161-D/IMB-161-L: SATA2
19,20 : SATA2

21 : 4-pin ATX Power Input Connector

22 : TPM Header

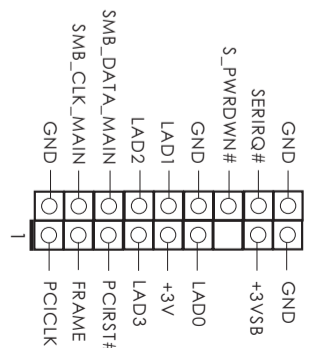

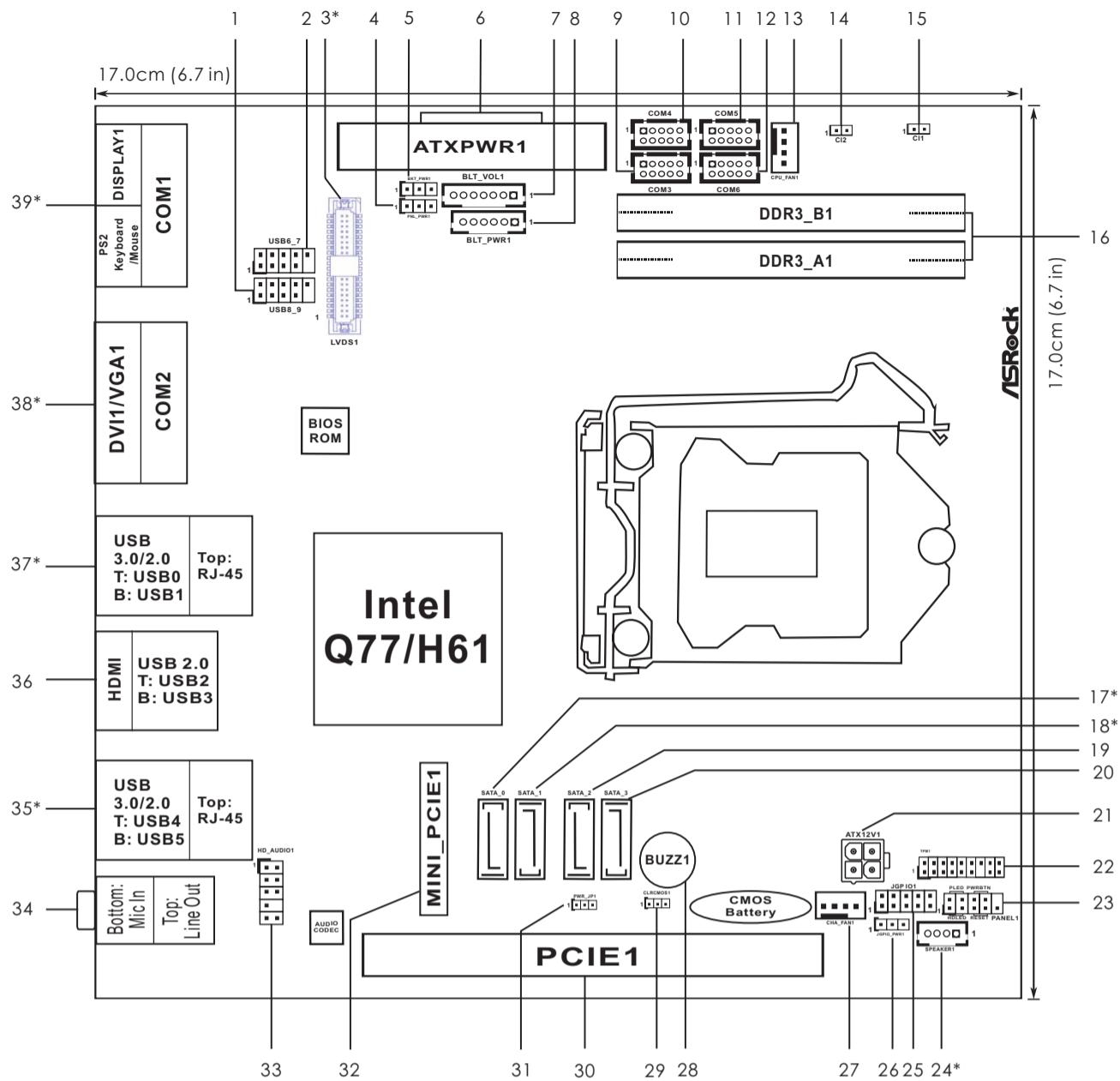

23 : System Panel Header

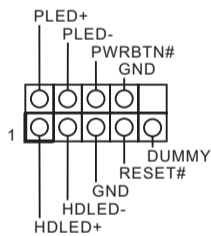

24* : 3W Audio AMP Output Wafer
(For IMB-171-L and IMB-161-L only)

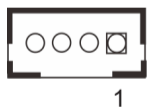

PIN	Signal Name
1	SPK L-
2	SPK L+
3	SPK R+
4	SPK R-

25 : Digital Input / Output Pin Header

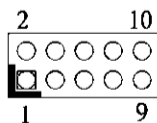

PIN	Signal Name	PIN	Signal Name
1	SIO_GP24	2	SIO_GP20
3	SIO_GP25	4	SIO_GP21
5	SIO_GP26	6	SIO_GP22
7	SIO_GP27	8	SIO_GP23
9	JGPIO_PWR1	10	GND

26 : Digital Input / Output Power select
1-2: +12V
2-3: +5V

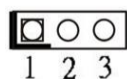

27 : 4-Pin Chassis FAN Connector (+12V)

28 : Buzzer

29 : Clear CMOS Header
1-2: Normal
2-3: Clear CMOS

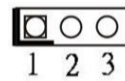

30 : PCIE1 Slot

31 : ATX/AT mode Selection
1-2: AT mode
2-3: ATX mode

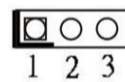

32 : mini-PCIE Slot

33 : Front Panel Audio Header

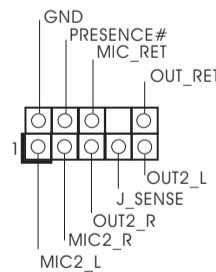

34 : Audio Jacks
Green - Line Out
Pink - Mic In

35* : Top : RJ45 LAN Port 2
Bottom :
IMB-171-D/IMB-171-L:
USB3.0 (USB45)
IMB-161-D/IMB-161-L:
USB2.0 (USB45)

36 : Top : USB2.0 (USB23)
Bottom : HDMI

37* : Top : RJ45 LAN Port 1
Bottom :
IMB-171-D/IMB-171-L:
USB3.0 (USB01)
IMB-161-D/IMB-161-L:
USB2.0 (USB01)

38* : Top : COM2
Bottom :
IMB-171-D/IMB-161-D: DVI1
IMB-171-L/IMB-161-L: VGA1

39* : Top : COM1
Bottom left: Display1
(For IMB-171-D and IMB-161-D only)
Bottom right: PS/2 Keyboard/Mouse