



# ASRock® Jumpers and headers setting guide

## IMB-170

## IMB-170-V

The terms HDMI™ and HDMI High-Definition Multimedia Interface, and the HDMI logo are trademarks or registered trademarks of HDMI Licensing LLC in the United States and other countries.

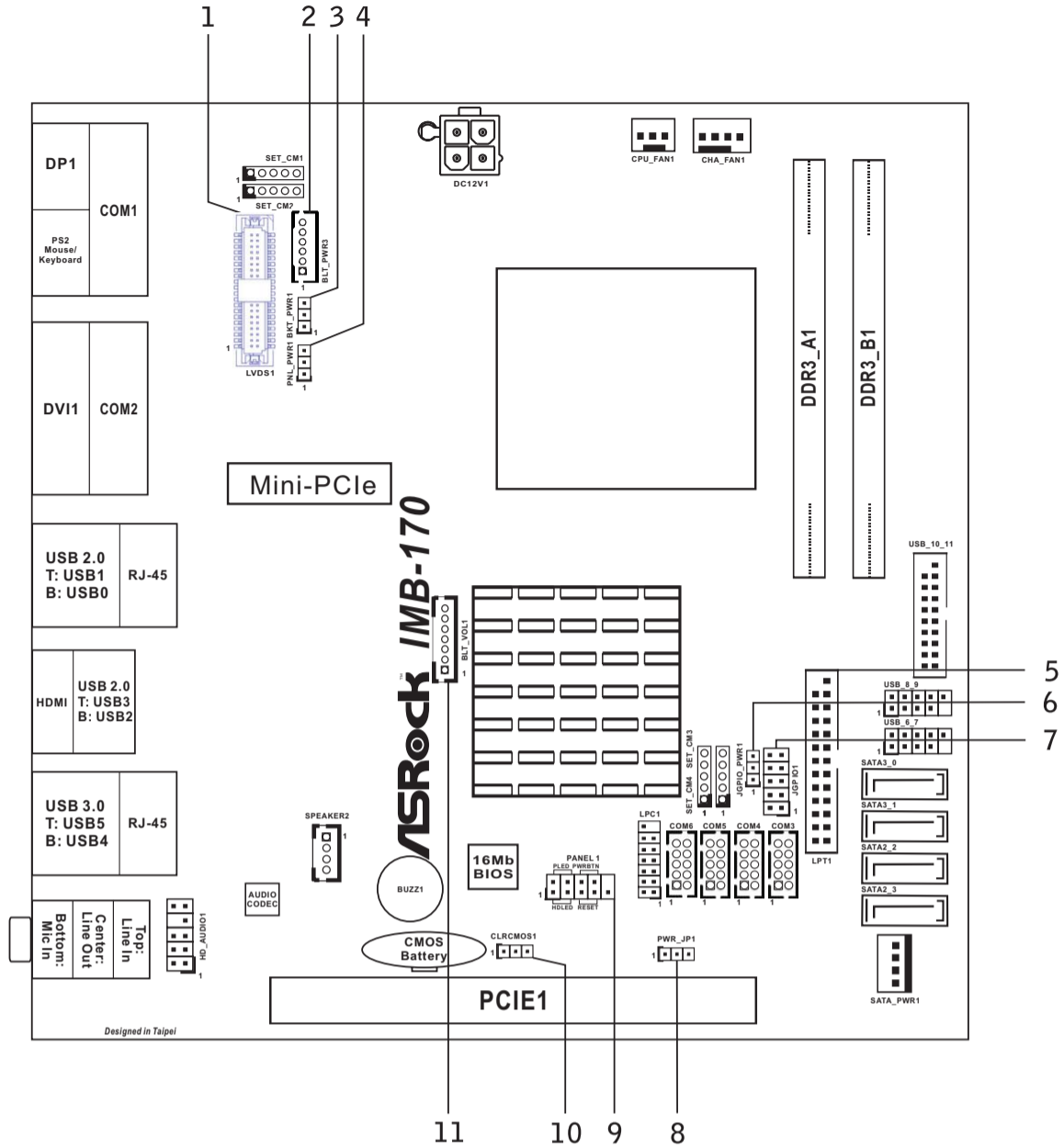

1 : LVDS Panel Connector

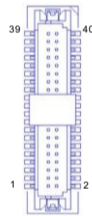

PIN	Signal Name	PIN	Signal Name
2	LCD PWR	1	LCD PWR
4	EDID CLK	3	EDID PWR
6	LVDSA D0-	5	EDID DATA
8	GND	7	LVDSA D0+
10	LVDSA D1+	9	LVDSA D1-
12	LVDSA D2-	11	GND
14	GND	13	LVDSA D2+
16	LVDSA D3+	15	LVDSA D3-
18	LVDSA CLK-	17	GND
20	GND	19	LVDSA CLK+
22	LVDSB D0+	21	LVDSB D0-
24	LVDSB D1-	23	GND
26	GND	25	LVDSB D1+
28	LVDSB D2+	27	LVDSB D2-
30	LVDSB D3-	29	DVLVDD_EN
32	GND	31	LVDSB D3+
34	LVDSB CLK+	33	LVDSB CLK-
36	BL EN	35	GND
38	BL PWR	37	BL CTRL
40	BL PWR	39	BL PWR

2 : Inverter Power Control Wafer Header



PIN	Signal Name
6	BL PWR
5	BL PWR
4	BL EN
3	BL CTRL
2	GND
1	GND

3 : Backlight Power Jumper

1-2 : +5V  
2-3 : +12V



4 : Panel Power Jumper

1-2 : +3V  
2-3 : +5V



5 : Printer Port Header

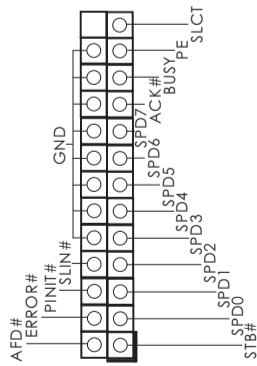

6 : Digital Input / Output Power Jumper

1-2 : +12V  
2-3 : +5V



7 : Digital Input / Output Pin Header

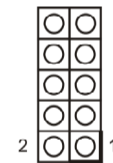

PIN	Signal Name	PIN	Signal Name
10	GND	9	GPIO PWR
8	SIO_GP23	7	SIO_GP27
6	SIO_GP22	5	SIO_GP26
4	SIO_GP21	3	SIO_GP25
2	SIO_GP20	1	SIO_GP24

8 : ATX/AT Mode Jumper

1-2: AT Mode  
2-3: ATX Mode

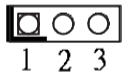

9 : System Panel Control Header

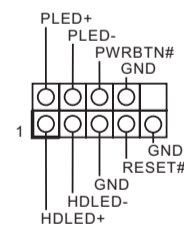

10 : Clear CMOS Jumper

1-2 : Normal Operation  
2-3 : Clear CMOS

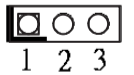

11 : Backlight & Amp Volume Control Header

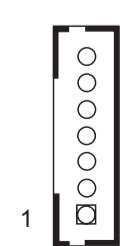

PIN	Signal Name
1	GPIO_VOL_UP
2	GPIO_VOL_DW
3	NC
4	GPIO_BLT_UP
5	GPIO_BLT_DW
6	GND
7	GND

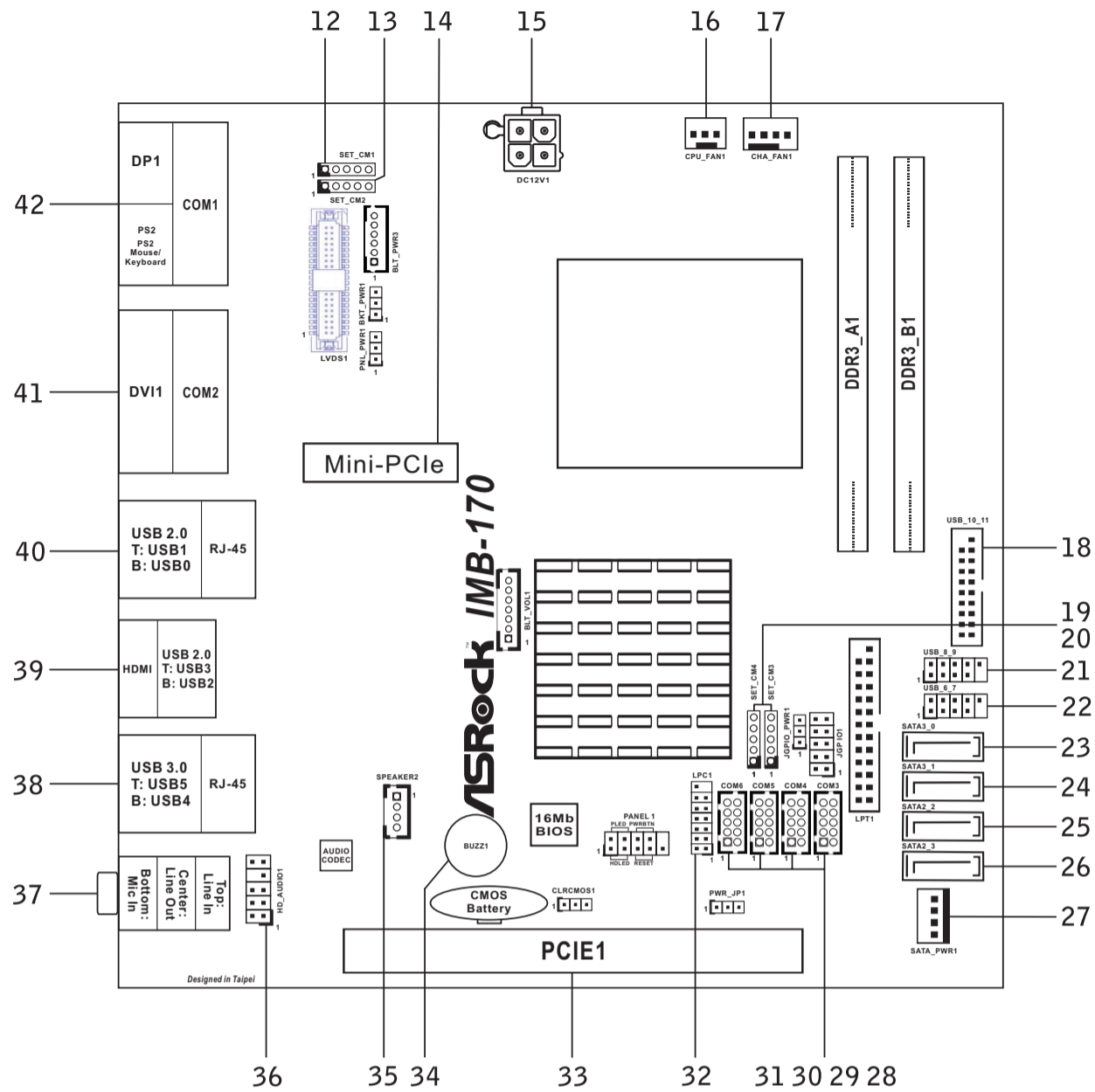

**COM Port Signal/Power Setting Jumpers**

- 12 : For COM1
- 13 : For COM2
- 19 : For COM4
- 20 : For COM3
- 1-2 : +12V
- 2-3 : +5V
- 4-5 : RI#

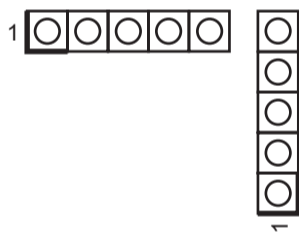

14 : mini PCIE Connector

- 15 : 4-Pin ATX PWR In (+12V)
- 16 : 3-Pin CPU FAN Connector (+12V)
- 17 : 4-Pin Chassis FAN Connector (+12V)

18 : USB3.0 Port

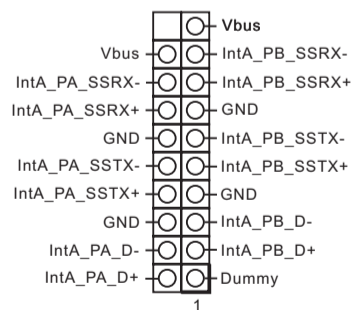

- 21 : USB 2.0 Port 8,9
- 22 : USB 2.0 Port 6,7

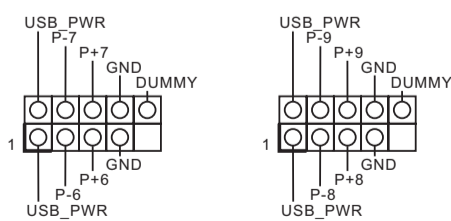

- 23 : SATA3\_0 Connector (White)
- 24 : SATA3\_1 Connector (White)
- 25 : SATA2\_2 Connector (Blue)
- 26 : SATA2\_3 Connector (Blue)

27 : SATA Power Connector

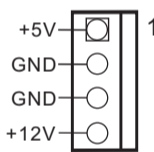

COM Port Headers (RS232)

- 28 : COM3
- 29 : COM4
- 30 : COM5
- 31 : COM6

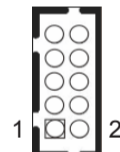

PIN	Signal Name	PIN	Signal Name
9	RI#/+5V/+12V	10	NC
7	RTS#	8	CTS#
5	GND	6	DSR#
3	TXD	4	DTR#
1	DCD#	2	RXD

32 : LPC Debug Header

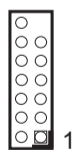

PIN	Signal Name	PIN	Signal Name
14	+3V	13	NC
12	+3V	11	+3V
10	GND	9	GND
8	LAD3	7	LAD2
6	LAD1	5	LAD0
4	LFRAME#	3	RESET#
2	GND	1	CLK

33 : PCIE Slot

34 : Buzzer

35 : 3W Audio AMP Output Wafer Header



PIN	Signal Name
1	SPK L-
2	SPK L+
3	SPK R+
4	SPK R-

36 : Front Panel Audio Header

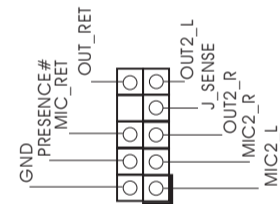

37 : Audio Jacks

- Blue - Line In
- Green - Line Out
- Pink - Mic In

38 : Top : RJ45 LAN Port2  
Bottom : USB3.0 (USB4,5)

39 : Top : USB2.0 (USB2,3)  
Bottom : HDMI

40 : Top : RJ45 LAN Port1  
Bottom : USB2.0 (USB0,1)

41 : Top : COM2 (RS232/422/485)\*  
Bottom : DVI (D-Sub for IMB-170-V)

42 : Top : COM1 (RS232/422/485)\*  
Bottom Left : Display Port  
Bottom Right : PS/2 Mouse/Keyboard

\* This motherboard supports RS232/422/485 on COM1, 2 ports. Please refer to below table for the pin definition. In addition, COM1, 2 ports (RS232/422/485) can be adjusted in BIOS setup utility > Advanced Screen > Super IO Configuration. You may refer to page 51 of our user manual for details.

**COM1, 2 Ports Pin Definition**

PIN	RS232	RS422	RS485
1	DCD	TX-	RTX-
2	RXD	RX+	N/A
3	TXD	TX+	RTX+
4	DTR	RX-	N/A
5	GND	GND	GND
6	DSR	N/A	N/A
7	RTS	N/A	N/A
8	CTS	N/A	N/A
9	+5V/+12V/R#	+5V/+12V/R#	+5V/+12V/R#