



IMB-190
IMB-190-E
IMB-191

User Manual

Version 1.1

Published July 2016

Copyright©2016 ASRock INC. All rights reserved.

Version 1.1

Published July 2016

Copyright©2016 ASRock INC. All rights reserved.

Copyright Notice:

No part of this documentation may be reproduced, transcribed, transmitted, or translated in any language, in any form or by any means, except duplication of documentation by the purchaser for backup purpose, without written consent of ASRock Inc.

Products and corporate names appearing in this documentation may or may not be registered trademarks or copyrights of their respective companies, and are used only for identification or explanation and to the owners' benefit, without intent to infringe.

Disclaimer:

Specifications and information contained in this documentation are furnished for informational use only and subject to change without notice, and should not be constructed as a commitment by ASRock. ASRock assumes no responsibility for any errors or omissions that may appear in this documentation.

With respect to the contents of this documentation, ASRock does not provide warranty of any kind, either expressed or implied, including but not limited to the implied warranties or conditions of merchantability or fitness for a particular purpose.

In no event shall ASRock, its directors, officers, employees, or agents be liable for any indirect, special, incidental, or consequential damages (including damages for loss of profits, loss of business, loss of data, interruption of business and the like), even if ASRock has been advised of the possibility of such damages arising from any defect or error in the documentation or product.

The terms HDMI™ and HDMI High-Definition Multimedia Interface, and the HDMI logo are trademarks or registered trademarks of HDMI Licensing LLC in the United States and other countries.



This device complies with Part 15 of the FCC Rules. Operation is subject to the following two conditions:

- (1) this device may not cause harmful interference, and
- (2) this device must accept any interference received, including interference that may cause undesired operation.

CALIFORNIA, USA ONLY

The Lithium battery adopted on this motherboard contains Perchlorate, a toxic substance controlled in Perchlorate Best Management Practices (BMP) regulations passed by the California Legislature. When you discard the Lithium battery in California, USA, please follow the related regulations in advance.

“Perchlorate Material-special handling may apply, see www.dtsc.ca.gov/hazardouswaste/perchlorate”

ASRock Website: <http://www.asrock.com>

CAUTION:

RISK OF EXPLOSION IF BATTERY IS REPLACED BY AN INCORRECT TYPE.
DISPOSE OF USED BATTERIES ACCORDING TO THE INSTRUCTIONS.

Contents

| | |
|---|-----------|
| 1 Introduction | 5 |
| 1.1 Package Contents | 5 |
| 1.2 Specifications..... | 6 |
| 1.3 Motherboard Layout..... | 12 |
| 1.4 I/O Panel..... | 14 |
| 2 Installation | 15 |
| 2.1 Screw Holes..... | 15 |
| 2.2 Pre-installation Precautions | 15 |
| 2.3 Installation of Memory Modules (SO-DIMM)..... | 16 |
| 2.4 Expansion Slots | 17 |
| 2.5 Jumpers Setup..... | 18 |
| 2.6 Onboard Headers and Connectors..... | 20 |
| 3 UEFI SETUP UTILITY..... | 26 |
| 3.1 Introduction | 26 |
| 3.1.1 UEFI Menu Bar | 26 |
| 3.1.2 Navigation Keys | 27 |
| 3.2 Main Screen..... | 27 |
| 3.3 Advanced Screen..... | 28 |
| 3.3.1 CPU Configuration | 29 |
| 3.3.2 Chipset Configuration..... | 31 |
| 3.3.3 Storage Configuration | 33 |
| 3.3.4 AMT Configuration | 34 |
| 3.3.5 Super IO Configuration | 36 |
| 3.3.6 ACPI Configuration..... | 37 |
| 3.3.7 USB Configuration | 38 |
| 3.4 Hardware Health Event Monitoring Screen | 39 |
| 3.5 Security Screen | 40 |
| 3.6 Boot Screen..... | 41 |
| 3.7 Exit Screen | 43 |
| 4 Software Support | 44 |
| 4.1 Install Operating System..... | 44 |
| 4.2 Support CD Information | 44 |
| 4.2.1 Running Support CD..... | 44 |
| 4.2.2 Drivers Menu..... | 44 |
| 4.2.3 Utilities Menu..... | 44 |
| 4.2.4 Contact Information..... | 44 |

Chapter 1: Introduction

Thank you for purchasing ASRock **IMB-190 / IMB-190-E / IMB-191** motherboard, a reliable motherboard produced under ASRock's consistently stringent quality control. It delivers excellent performance with robust design conforming to ASRock's commitment to quality and endurance.

In this manual, chapter 1 and 2 contain introduction of the motherboard and step-by-step guide to the hardware installation. Chapter 3 and 4 contain the configuration guide to BIOS setup and information of the Support CD.



Because the motherboard specifications and the BIOS software might be updated, the content of this manual will be subject to change without notice. In case any modifications of this manual occur, the updated version will be available on ASRock website without further notice. You may find the latest VGA cards and CPU support lists on ASRock website as well. ASRock website <http://www.asrock.com>

If you require technical support related to this motherboard, please visit our website for specific information about the model you are using. www.asrock.com/support/index.asp

1.1 Package Contents

ASRock **IMB-190 / IMB-190-E / IMB-191** Motherboard

(Mini-ITX Form Factor: 6.7-in x 6.7-in, 17.0 cm x 17.0 cm)

ASRock **IMB-190 / IMB-190-E / IMB-191** Driver CD

ASRock **IMB-190 / IMB-190-E / IMB-191** Jumper setting instruction

1 x I/O Panel Shield

1.2 Specifications

IMB-190:

| | | |
|-------------------------|-------------------|---|
| Form Factor | Dimensions | Mini-ITX (6.7-in x 6.7-in) |
| Processor System | CPU | Socket LGA1151 for Intel® Core i7/i5/i3/Celeron (Skylake-S) |
| | Core Number | (By CPU, Max 4) |
| | Max Speed | (By CPU) |
| | L3 Cache | (By CPU) |
| | Chipset | Intel® Q170 |
| | BIOS | UEFI |
| Expansion Slot | PCIe | 0 |
| | Mini-PCIe | 2 x Mini-PCIe (1 x full size colay with mSATA, 1 x half size, both with USB signal) |
| | mSATA | 1 (colay with full size Mini-PCIe) |
| | PCIe | 1 x PCIe x4 slot |
| | CFast Card Socket | 0 |
| Memory | Technology | Dual Channel DDR4 2133MHz SDRAM |
| | Max. | 32GB |
| | Socket | 2 x SO-DIMM |
| Graphics | Controller | Intel® Gen9 Graphics DX 11/12, OGL4.3/4.4 |
| | VRAM | Shared Memory |
| | VGA | Supports max. resolution 1920 x 1200 |
| | LVDS | Supports max resolution 1920 x 1080 2ch-24bit |
| | HDMI | HDMI1: Supports HDMI 2.0, max resolution 4096 x 2160 @ 60Hz, 24bpp HDMI2,3: Supports HDMI 1.4a, max resolution 4096 x 2160 @ 24Hz, 24bpp / 3840 x 2160 @ 30Hz, 24bpp |
| | DVI | 0 |
| | DisplayPort | 0 |
| | Multi Display | Yes (Triple Display) |
| Ethernet | Ethernet | 10/100/1000 Mbps |
| | Controller | 1 x Intel® i210 1 x Intel® i219LM |
| | Connector | 2 x RJ-45 |

| | | |
|---------------------------|------------------------|---|
| SATA | Max Data Transfer Rate | SATA3 (6.0Gb/s) |
| | Rear I/O | |
| | VGA | 0 |
| | DVI | 0 |
| | HDMI | 3 |
| | DisplayPort | 0 |
| | Ethernet | 2 |
| | USB | 4 x USB 3.0 |
| | Audio | 2 (Mic-in. Line-out) |
| | Serial | 0 |
| | PS/2 | 0 |
| Internal Connector | USB | 4 (2 x 2.54 pitch header USB 2.0 compliant) |
| | LVDS/inverter | 1/1 |
| | eDP | 0 |
| | VGA | 1 |
| | Serial | 4 x RS-232 (COM1, 2 support RS-232/422/485) |
| | SATA | 2 x SATA3 (6.0Gb/s) |
| | mPCIe | 2 |
| | Parallel | 0 |
| | mSATA | 1 |
| | IrDA | 0 |
| | GPIO | 4 x GPI, 4 x GPO |
| | SATA PWR Output Con | 1 |
| | Speaker Header | 1 |
| | Watchdog Timer | |
| | Output | From Super I/O to drag RESETCON# |
| | Interval | 256 segments, 0,1,2...255sec/min |
| Power Requirements | Input PWR | 12V / 19~24V DC-in (DC Jack / 4-pin ATX PWR Con, choose either of the two) |
| | Power On | AT/ATX Supported AT : Directly PWR on as power input ready ATX : Press button to PWR on after power input ready |
| Environment | Temperature | 0°C – 60°C |

IMB-190-E:

| | | |
|-------------------------|-------------------|---|
| Form Factor | Dimensions | Mini-ITX (6.7-in x 6.7-in) |
| Processor System | CPU | Socket LGA1151 for Intel® Core i7/i5/i3/Celeron (Skylake-S) |
| | Core Number | (By CPU, Max 4) |
| | Max Speed | (By CPU) |
| | L3 Cache | (By CPU) |
| | Chipset | Intel® Q170 |
| | BIOS | UEFI |
| Expansion Slot | PCIe | 0 |
| | Mini-PCIe | 2 x Mini-PCIe (1 x full size colay with mSATA, 1 x half size, both with USB signal) |
| | mSATA | 1 (colay with full size Mini-PCIe) |
| | PCIe | 1 x PCIe x4 slot |
| | CFast Card Socket | 0 |
| Memory | Technology | Dual Channel DDR4 2133MHz SDRAM |
| | Max. | 32GB |
| | Socket | 2 x SO-DIMM |
| Graphics | Controller | Intel® Gen9 Graphics DX 11/12, OGL4.3/4.4 |
| | VRAM | Shared Memory |
| | VGA | Supports max. resolution 1920 x 1200 |
| | eDP | Supports max resolution 4096 x 2160 @ 60Hz, 24bpp |
| | HDMI | HDMI1: Supports HDMI 2.0, max resolution 4096 x 2160 @ 60Hz, 24bpp HDMI2,3: Supports HDMI 1.4a, max resolution 4096 x 2160 @ 24Hz, 24bpp / 3840 x 2160 @ 30Hz, 24bpp |
| | DVI | 0 |
| | DisplayPort | 0 |
| | Multi Display | Yes (Triple Display) |
| Ethernet | Ethernet | 10/100/1000 Mbps |
| | Controller | 1 x Intel® i210 1 x Intel® i219LM |
| | Connector | 2 x RJ-45 |

| | | |
|---------------------------|------------------------|---|
| SATA | Max Data Transfer Rate | SATA3 (6.0Gb/s) |
| Rear I/O | VGA | 0 |
| | DVI | 0 |
| | HDMI | 3 |
| | DisplayPort | 0 |
| | Ethernet | 2 |
| | USB | 4 x USB 3.0 |
| | Audio | 2 (Mic-in. Line-out) |
| | Serial | 0 |
| | PS/2 | 0 |
| Internal Connector | USB | 4 (2 x 2.54 pitch header USB 2.0 compliant) |
| | LVDS/inverter | 0/0 |
| | eDP | 1 |
| | VGA | 0 |
| | Serial | 4 x RS-232 (COM1, 2 support RS-232/422/485) |
| | SATA | 2 x SATA3 (6.0Gb/s) |
| | mPCIe | 2 |
| | Parallel | 0 |
| | mSATA | 1 |
| | IrDA | 0 |
| | GPIO | 4 x GPI, 4 x GPO |
| | SATA PWR Output Con | 1 |
| | Speaker Header | 1 |
| | Watchdog Timer | Output |
| Interval | | 256 segments, 0,1,2...255sec/min |
| Power Requirements | Input PWR | 12V / 19~24V DC-in (DC Jack / 4-pin ATX PWR Con, choose either of the two) |
| | Power On | AT/ATX Supported AT : Directly PWR on as power input ready ATX : Press button to PWR on after power input ready |
| Environment | Temperature | 0°C – 60°C |

IMB-191:

| | | |
|-------------------------|-------------------|--|
| Form Factor | Dimensions | Mini-ITX (6.7-in x 6.7-in) |
| Processor System | CPU | Socket LGA1151 for Intel® Core i7/i5/i3/Celeron (Skylake-S) |
| | Core Number | (By CPU, Max 4) |
| | Max Speed | (By CPU) |
| | L3 Cache | (By CPU) |
| | Chipset | Intel® H110 |
| | BIOS | UEFI |
| Expansion Slot | PCIe | 0 |
| | Mini-PCIe | 1 (1 x half size) |
| | mSATA | 1 |
| | PCIe | 1 x PCIe x4 slot |
| | CFast Card Socket | 0 |
| Memory | Technology | Dual Channel DDR4 2133MHz SDRAM |
| | Max. | 32GB |
| | Socket | 2 x SO-DIMM |
| Graphics | Controller | Intel® Gen9 Graphics DX 11/12, OGL4.3/4.4 |
| | VRAM | Shared Memory |
| | VGA | Supports max. resolution 1920 x 1200 |
| | LVDS | Supports max resolution 1920 x 1080 2ch-24bit |
| | HDMI | Supports HDMI 1.4a, max resolution 4096 x 2160 @ 24Hz, 24bpp |
| | DVI | 0 |
| | DisplayPort | 0 |
| | Multi Display | Yes (Dual Display) |
| Ethernet | Ethernet | 10/100/1000 Mbps |
| | Controller | 1 x Intel® i210 1 x Intel® i219V |
| | Connector | 2 x RJ-45 |

| | | |
|---------------------------|------------------------|---|
| SATA | Max Data Transfer Rate | SATA3 (6.0Gb/s) |
| | Rear I/O | |
| | VGA | 0 |
| | DVI | 0 |
| | HDMI | 2 |
| | DisplayPort | 0 |
| | Ethernet | 2 |
| | USB | 4 x USB 3.0 |
| | Audio | 2 (Mic-in. Line-out) |
| | Serial | 0 |
| | PS/2 | 0 |
| Internal Connector | USB | 4 (2 x 2.54 pitch header USB 2.0 compliant) |
| | LVDS/inverter | 1/1 |
| | eDP | 0 |
| | VGA | 1 |
| | Serial | 4 x RS-232 (COM1, 2 support RS-232/422/485) |
| | SATA | 2 x SATA3 (6.0Gb/s) |
| | mPCIe | 1 |
| | Parallel | 0 |
| | mSATA | 1 |
| | IrDA | 0 |
| | GPIO | 4 x GPI, 4 x GPO |
| | SATA PWR Output Con | 1 |
| | Speaker Header | 1 |
| | Watchdog Timer | Output |
| Interval | | 256 segments, 0,1,2...255sec/min |
| Power Requirements | Input PWR | 12V / 19~24V DC-in (DC Jack / 4-pin ATX PWR Con, choose either of the two) |
| | Power On | AT/ATX Supported AT : Directly PWR on as power input ready ATX : Press button to PWR on after power input ready |
| Environment | Temperature | 0°C – 60°C |

-
- 1 : 2-pin UPS Module Power Input Connector
 - 2 : 4-pin ATX Power Input/Output Connector
 - 3 : USB2.0 Headers (USB2_0_1, USB2_2_3)
 - 4 : SATA3 Connectors (SATA3_1, SATA3_2)
 - 5 : COM1, 2, 3, 4 PWR Setting Jumpers
 - 6 : Digital Input / Output Pin Header
 - 7 : ATX/AT Mode Jumper (PWR_JP1)
 - 8 : COM Port Header (COM1)
 - 9 : COM Port Header (COM2)
 - 10 : COM Port Header (COM3)
 - 11 : COM Port Header (COM4)
 - 12 : System Panel Header
 - 13 : Digital Input / Output Power Select (JGPIO_PWR1)
 - 14 : Digital Input / Output Default Value Setting (JGPIO_SET1)
 - 15* : LVDS Panel Connector (Only for IMB-190 / IMB-191)
 - * eDP Connector (on the Backside of PCB) (Only for IMB-190-E)
 - 16 : Panel Power Select (PNL_PWR1)
 - 17 : BLT_CTL1
 - 18 : Backlight Control Level (BLT_PWM1) (CON_LBKL_CTL)
 - 19 : BL1, BL2
 - 20 : Backlight Power Select (BKT_PWR1)
 - 21 : mSATA Select
 - 22 : Clear CMOS Header
 - 23 : Speaker Control
 - 24 : Buzzer
 - 25 : 3W Audio AMP Output Wafer
 - 26* : VGA Header (Only for IMB-190 / IMB-191)
 - 27 : Front Panel Audio Header
 - 28 : LPC Header
 - 29 : Chassis Intrusion Headers (CI1, CI2)
 - 30 : 4-Pin CPU FAN Connector (+12V)
 - 31 : 4-Pin Chassis FAN Connector (+12V)
 - 32 : SATA Power Output Connector

* HDMI1 is only for IMB-190 / IMB-190-E.

1.4 I/O Panel

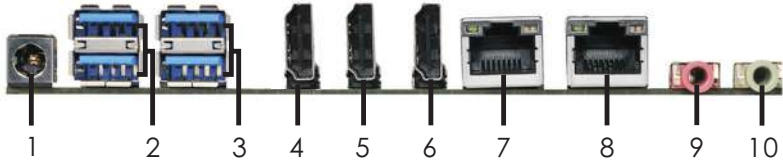

- | | | | |
|---|-----------------------------------|----|-------------------|
| 1 | DC Jack (12V / 19~24V) (DC_JACK1) | 6 | HDMI Port (HDMI3) |
| 2 | USB 3.0 Ports (USB3_0_1) | 7 | LAN RJ-45 Port** |
| 3 | USB 3.0 Ports (USB3_2_3) | 8 | LAN RJ-45 Port** |
| 4 | HDMI Port (HDMI1)* | 9 | Microphone (Pink) |
| 5 | HDMI Port (HDMI2) | 10 | Line out (Lime) |

* HDMI1 is only for IMB-190 / IMB-190-E.

** There are two LED next to the LAN port. Please refer to the table below for the LAN port LED indications.

LAN Port LED Indications

Activity/Link LED

| Status | Description |
|----------|---------------|
| Off | No Link |
| Blinking | Data Activity |
| On | Link |

SPEED LED

| Status | Description |
|--------|--------------------|
| Off | 10Mbps connection |
| Off | 100Mbps connection |
| Green | 1Gbps connection |

SPEED LED ACT/LINK LED



LAN Port

Chapter 2: Installation

This is a Mini-ITX form factor (6.7" x 6.7", 17.0 x 17.0 cm) motherboard. Before you install the motherboard, study the configuration of your chassis to ensure that the motherboard fits into it.



Make sure to unplug the power cord before installing or removing the motherboard. Failure to do so may cause physical injuries to you and damages to motherboard components.

2.1 Screw Holes

Place screws into the holes to secure the motherboard to the chassis.



Do not over-tighten the screws! Doing so may damage the motherboard.

2.2 Pre-installation Precautions

Take note of the following precautions before you install motherboard components or change any motherboard settings.

1. Unplug the power cord from the wall socket before touching any component.
2. To avoid damaging the motherboard components due to static electricity, NEVER place your motherboard directly on the carpet or the like. Also remember to use a grounded wrist strap or touch a safety grounded object before you handle components.
3. Hold components by the edges and do not touch the ICs.
4. Whenever you uninstall any component, place it on a grounded antistatic pad or in the bag that comes with the component.



Before you install or remove any component, ensure that the power is switched off or the power cord is detached from the power supply. Failure to do so may cause severe damage to the motherboard, peripherals, and/or components.

2.3 Installation of Memory Modules (SO-DIMM)

IMB-190 / IMB-190-E / IMB-191 provides two 204-pin DDR4 (Double Data Rate 4) SO-DIMM slots.

Step 1. Align a SO-DIMM on the slot such that the notch on the SO-DIMM matches the break on the slot.

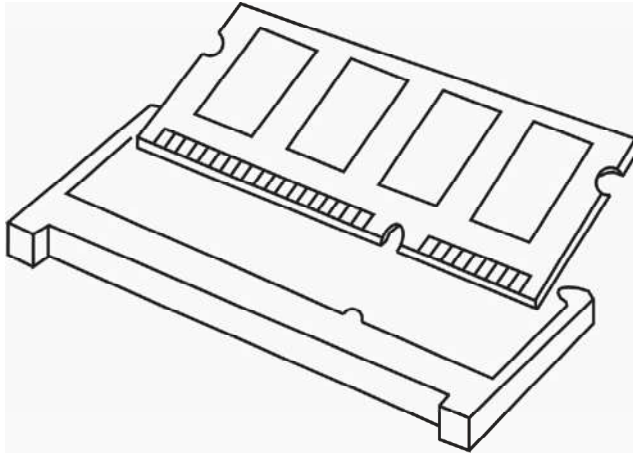

1. The SO-DIMM only fits in one correct orientation. It will cause permanent damage to the motherboard and the SO-DIMM if you force the SO-DIMM into the slot at incorrect orientation.
2. Please do not intermix different voltage SO-DIMMs on this motherboard.

Step 2. Firmly insert the SO-DIMM into the slot until the retaining clips at both ends fully snap back in place and the SO-DIMM is properly seated.

2.4 Expansion Slots

There is 1 mini-PCIe slot, 1 mini-PCIe / mini-SATA slot and 1 PCI Express slot on this motherboard.

mini-PCIe slot:

MINI_PCIE1 (mini-PCIe slot; half size) is used for PCI Express mini cards.

mini-PCIe / mini-SATA slot:

MINI_SATA1 (mini-PCIe / mini-SATA slot; full size) is used for PCI Express mini cards or mSATA cards.

* MINI_SATA1 on IMB-191 supports mSATA cards only.

PCIe slot: PCIE1 (PCIe x4 slot) is used for PCI Express x4 lane width cards.



Installing an expansion card

- Step 1. Before installing the expansion card, please make sure that the power supply is switched off or the power cord is unplugged. Please read the documentation of the expansion card and make necessary hardware settings for the card before you start the installation.
- Step 2. Remove the system unit cover (if your motherboard is already installed in a chassis).
- Step 3. Remove the bracket facing the slot that you intend to use. Keep the screws for later use.
- Step 4. Align the card connector with the slot and press firmly until the card is completely seated on the slot.
- Step 5. Fasten the card to the chassis with screws.
- Step 6. Replace the system cover.

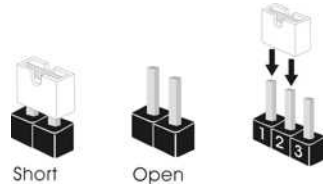

2.5 Jumpers Setup

The illustration shows how jumpers are setup. When the jumper cap is placed on pins, the jumper is “Short”. If no jumper cap is placed on pins, the jumper is “Open”. The illustration shows a 3-pin jumper whose pin1 and pin2 are “Short” when jumper cap is placed on these 2 pins.



| Jumper | Setting | Description |
|---|---|-------------|
| Clear CMOS Jumper (3-pin CLRCMOS1) (see p.12, No. 22) | <div style="display: flex; justify-content: space-around;"> <div style="text-align: center;"> <p>1_2</p>  <p>Default</p> </div> <div style="text-align: center;"> <p>2_3</p>  <p>Clear CMOS</p> </div> </div> | |

Note: CLRCMOS1 allows you to clear the data in CMOS. To clear and reset the system parameters to default setup, please turn off the computer and unplug the power cord from the power supply. After waiting for 15 seconds, use a jumper cap to short pin2 and pin3 on CLRCMOS1 for 5 seconds. However, please do not clear the CMOS right after you update the BIOS. If you need to clear the CMOS when you just finish updating the BIOS, you must boot up the system first, and then shut it down before you do the clear-CMOS action. Please be noted that the password, date, time, user default profile and MAC address will be cleared only if the CMOS battery is removed.

| | | |
|--|--|---|
| AT/ATX Mode Select (3-pin PWR_JP1) (see p.12, No. 7) |  1 2 3 | 1-2 : AT Mode 2-3 : ATX Mode |
| Digital Input / Output Power Select (3-pin JGPIO_PWR1) (see p.12, No. 13) |  1 2 3 | 1-2 : +12V 2-3 : +5V |
| Digital Input / Output Default Value Setting (3-pin JGPIO_SET1) (see p.12, No. 14) |  1 2 3 | 1-2 : Pull-High (+3V) 2-3 : Pull-Low |

Speaker Control

(3-pin AMP_CTL1)
(see p.12, No. 23)



| PIN | Signal Name |
|-----|-------------|
| 1 | GPIO_VOL_DW |
| 2 | GND |
| 3 | GPIO_VOL_UP |

Backlight Control Level (CON_LBKLT_CTL)

(3-pin BLT_PWM1)
(see p.12, No. 18)



1-2 : +3.3V
2-3 : +5V

Panel Power Select

(4-pin PNL_PWR1)
(see p.12, No. 18)

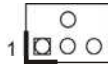

| PIN | Signal Name | PIN | Signal Name | PIN | Signal Name |
|-----|-------------|-----|-------------|-----|-------------|
| 2 | NC | 4 | +12V | 6 | NC |
| 1 | +3.3V | 3 | LCD_VCC | 5 | +5V |

Backlight Power Select

(4-pin BKT_PWR1)
(see p.12, No. 20)

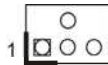

| PIN | Signal Name | PIN | Signal Name | PIN | Signal Name |
|-----|-------------|-----|-------------|-----|-------------|
| 2 | NC | 4 | +VIN | 6 | NC |
| 1 | +5V | 3 | LCD_BLT_VCC | 5 | +12V |

COM1, 2, 3, 4 PWR Setting Jumpers

(3-pin SET_CM1, SET_CM2, SET_CM3, SET_CM4)
(see p.12, No. 5)



1-2 : +5V
2-3 : +12V

BL1, BL2

(2-pin BL1, BL2)
(see p.12 No. 19)



BL1 :
Open : Protect LCD_BLT_VCC
Short : No Protect LCD_BLT_VCC
BL2 :
Open : Protect LCD_VCC
Short : No Protect LCD_VCC

mSATA Select

(2-pin MSATA_SEL1)
(see p.12, No. 21)



Open : For mini-PCIe
Short : For mini-SATA

2.6 Onboard Headers and Connectors



Onboard headers and connectors are NOT jumpers. Do NOT place jumper caps over these headers and connectors. Placing jumper caps over the headers and connectors will cause permanent damage of the motherboard!

CPU Fan Connector

(4-pin CPU_FAN1)

(see p.12 No. 30)

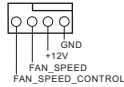

Please connect the CPU fan cable to the connector and match the black wire to the ground pin.



Though this motherboard provides 4-Pin CPU fan (Quiet Fan) support, the 3-Pin CPU fan still can work successfully even without the fan speed control function. If you plan to connect the 3-Pin CPU fan to the CPU fan connector on this motherboard, please connect it to Pin 1-3.

Chassis Fan Connector

(4-pin CHA_FAN1)

(see p.12 No. 31)

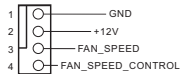

Please connect the chassis fan cable to the connector and match the black wire to the ground pin.



Though this motherboard provides 4-Pin chassis fan (Quiet Fan) support, the 3-Pin chassis fan still can work successfully even without the fan speed control function. If you plan to connect the 3-Pin chassis fan to the chassis fan connector on this motherboard, please connect it to Pin 1-3.

Digital Input / Output Pin Header

(10-pin JGPIO1)

(see p.12, No. 6)

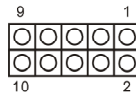

| PIN | Signal Name | PIN | Signal Name | PIN | Signal Name | PIN | Signal Name | PIN | Signal Name |
|-----|-------------|-----|-------------|-----|-------------|-----|-------------|-----|-------------|
| 9 | JGPIO_PWR | 7 | SIO_GP27 | 5 | SIO_GP26 | 3 | SIO_GP25 | 1 | SIO_GP24 |
| 10 | GND | 8 | SIO_GP23 | 6 | SIO_GP22 | 4 | SIO_GP21 | 2 | SIO_GP20 |

Chassis Intrusion Headers

(2-pin C11, C12: see p.12, No. 29)



This motherboard supports CASE OPEN detection feature that detects if the chassis cover has been removed. This feature requires a chassis with chassis intrusion detection design.
Close: Active Case Open
Open: Normal

COM Port Headers

(10-pin COM1: see p.12, No. 8)

(10-pin COM2: see p.12, No. 9)

(10-pin COM3: see p.12, No. 10)

(10-pin COM4: see p.12, No. 11)

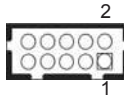

| PIN | Signal Name | PIN | Signal Name | PIN | Signal Name | PIN | Signal Name | PIN | Signal Name |
|-----|-------------|-----|-------------|-----|-------------|-----|-------------|-----|-------------|
| 10 | N/A | 8 | CCTS# | 6 | DDSR# | 4 | DDTR# | 2 | RRXD# |
| 9 | +5V | 7 | RRTS# | 5 | GND | 3 | TTXD | 1 | DDCD# |



This motherboard supports RS232/422/485 on COM1, 2 ports. Please refer to below table for the pin definition. In addition, COM1, 2 ports (RS232/422/485) can be adjusted in BIOS setup utility > Advanced Screen > Super IO Configuration. You may refer to page 36 for details.

COM1, 2 Port Pin Definition

| PIN | RS232 | RS422 | RS485 |
|-----|-------|-------|-------|
| 1 | DCD | TX- | RTX- |
| 2 | RXD | RX+ | N/A |
| 3 | TXD | TX+ | RTX+ |
| 4 | DTR | RX- | N/A |
| 5 | GND | GND | GND |
| 6 | DSR | N/A | N/A |
| 7 | RTS | N/A | N/A |
| 8 | CTS | N/A | N/A |
| 9 | +5V | +5V | +5V |
| 10 | NC | NC | NC |

System Panel Header

(9-pin PANEL1)

(see p.12, No. 12)

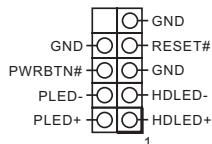

This header accommodates several system front panel functions.



Connect the power switch, reset switch and system status indicator on the chassis to this header according to the pin assignments below. Note the positive and negative pins before connecting the cables.

PWRBTN (Power Switch):

Connect to the power switch on the chassis front panel. You may configure the way to turn off your system using the power switch.

RESET (Reset Switch):

Connect to the reset switch on the chassis front panel. Press the reset switch to restart the computer if the computer freezes and fails to perform a normal restart.

PLED (System Power LED):

Connect to the power status indicator on the chassis front panel. The LED is on when the system is operating. The LED keeps blinking when the system is in S1/S3 sleep state. The LED is off when the system is in S4 sleep state or powered off (S5).

HDLED (Hard Drive Activity LED):

Connect to the hard drive activity LED on the chassis front panel. The LED is on when the hard drive is reading or writing data.

The front panel design may differ by chassis. A front panel module mainly consists of power switch, reset switch, power LED, hard drive activity LED, speaker and etc. When connecting your chassis front panel module to this header, make sure the wire assignments and the pin assignments are matched correctly.

SATA3 Connectors

(SATA3_1, SATA3_2: see p.12, No. 4)

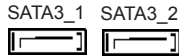

These two Serial ATA3 (SATA3) connectors support SATA data cables for internal storage devices. The current SATA3 interface allows up to 6.0 Gb/s data transfer rate.

USB 2.0 Headers

(9-pin USB2_0_1, USB2_2_3:

see p.12, No. 3)

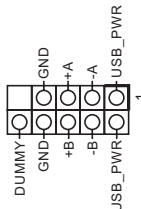

There are two headers on this motherboard. Each USB 2.0 header can support two ports.

Front Panel Audio Header

(9-pin HD_AUDIO1)

(see p.12 No. 27)

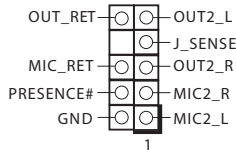

This is an interface for front panel audio cable that allows convenient connection and control of audio devices.



1. High Definition Audio supports Jack Sensing, but the panel wire on the chassis must support HDA to function correctly. Please follow the instruction in our manual and chassis manual to install your system.
2. If you use AC'97 audio panel, please install it to the front panel audio header as below:
 - A. Connect Mic_IN (MIC) to MIC2_L.
 - B. Connect Audio_R (RIN) to OUT2_R and Audio_L (LIN) to OUT2_L.
 - C. Connect Ground (GND) to Ground (GND).
 - D. MIC_RET and OUT_RET are for HD audio panel only. You don't need to connect them for AC'97 audio panel.
 - E. To activate the front mic.

Go to the "FrontMic" Tab in the Realtek Control panel. Adjust "Recording Volume".

LPC Header

(19-pin LPC1)

(see p.12, No. 28)

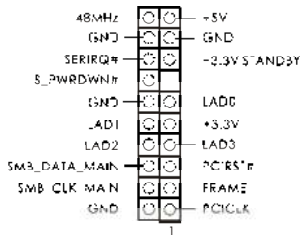

This connector supports a Trusted Platform Module (TPM) system, which can securely store keys, digital certificates, passwords, and data. A TPM system also helps enhance network security, protects digital identities, and ensures platform integrity.

ATX Power Input/Output Connector

(4-pin INT_DC1)

(see p.12 No. 2)

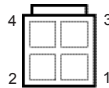

Please connect a DC 12V/19~24V power supply to this connector.

1-2 : GND
3-4 : DC Input (12V/19~24V)

UPS Module Power Input Connector

(2-pin UPS_IN1)

(see p.12 No. 1)



Please connect a UPS module power supply to this connector.

LVDS Connector (Only for IMB-190 / IMB-191)

(40-pin LVDS1)

(see p.12 No. 15)

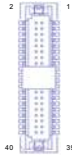

| PIN | Signal Name | PIN | Signal Name |
|-----|---------------|-----|---------------|
| 2 | LCD_VCC | 1 | LCD_VCC |
| 4 | LDDC_CLK | 3 | +3.3V |
| 6 | LVDS_A_DATA0# | 5 | LDDC_DATA |
| 8 | GND | 7 | LVDS_A_DATA0 |
| 10 | LVDS_A_DATA1 | 9 | LVDS_A_DATA1# |
| 12 | LVDS_A_DATA2# | 11 | GND |
| 14 | GND | 13 | LVDS_A_DATA2 |
| 16 | LVDS_A_DATA3 | 15 | LVDS_A_DATA3# |
| 18 | LVDS_A_CLK# | 17 | GND |
| 20 | GND | 19 | LVDS_A_CLK |
| 22 | LVDS_B_DATA0 | 21 | LVDS_B_DATA0# |
| 24 | LVDS_B_DATA1# | 23 | GND |
| 26 | GND | 25 | LVDS_B_DATA1 |
| 28 | LVDS_B_DATA2 | 27 | LVDS_B_DATA2# |
| 30 | LVDS_B_DATA3# | 29 | DPLVDD_EN |
| 32 | GND | 31 | LVDS_B_DATA3 |
| 34 | LVDS_B_CLK | 33 | LVDS_B_CLK# |
| 36 | CON_LBKLT_EN | 35 | GND |
| 38 | LCD_BLT_VCC | 37 | CON_LBKLT_CTL |
| 40 | LCD_BLT_VCC | 39 | LCD_BLT_VCC |

* eDP Connector (on the Backside of PCB)

(Only for IMB-190-E)

(40-pin EDP1)

(see p.12 No. 15)



| PIN | Signal Name |
|-----|---------------|
| 40 | NA |
| 39 | LCD_BLT_VCC |
| 38 | LCD_BLT_VCC |
| 37 | LCD_BLT_VCC |
| 36 | LCD_BLT_VCC |
| 35 | SMB_CLK |
| 34 | SMB_DATA |
| 33 | CON_LBKLT_CTL |
| 32 | CON_LBKLT_EN |
| 31 | GND |
| 30 | GND |
| 29 | GND |
| 28 | GND |
| 27 | eDP_HPD_CON |
| 26 | GND |
| 25 | GND |
| 24 | GND |
| 23 | GND |
| 22 | NA |
| 21 | LCD_VCC |
| 20 | LCD_VCC |
| 19 | LCD_VCC |
| 18 | LCD_VCC |
| 17 | GND |
| 16 | eDP_AUX#_CON |
| 15 | eDP_AUX_CON |
| 14 | GND |
| 13 | eDP_TX0_CON |
| 12 | eDP_TX#0_CON |
| 11 | GND |
| 10 | eDP_TX1_CON |
| 9 | eDP_TX#1_CON |
| 8 | GND |
| 7 | eDP_TX2_CON |
| 6 | eDP_TX#2_CON |
| 5 | GND |
| 4 | eDP_TX3_CON |
| 3 | eDP_TX#3_CON |
| 2 | GND |
| 1 | NA |

SATA Power Output Connector

(SATA_PWR1)

(see p.12 No. 32)

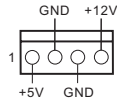

Please connect a SATA power cable to this connector.

3W Audio AMP Output Wafer

(4-pin SPEAKER1)

(see p.12 No. 25)



| PIN | Signal Name | PIN | Signal Name | PIN | Signal Name | PIN | Signal Name |
|-----|-------------|-----|-------------|-----|-------------|-----|-------------|
| 4 | SPK R- | 3 | SPK R+ | 2 | SPK L+ | 1 | SPK L- |

Buzzer

(2-pin BUZZ2)

(see p.12 No. 24)



BLT_CTL1

(8-pin BLT_CTL1)

(see p.12 No. 17)

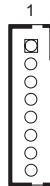

| PIN | Signal Name |
|-----|---------------|
| 1 | CON_LBKL_T_EN |
| 2 | CON_LBKL_CTL |
| 3 | LCD_BLT_VCC |
| 4 | LCD_BLT_VCC |
| 5 | GND |
| 6 | GND |
| 7 | GPIO_BLT_UP |
| 8 | GPIO_BLT_DW |

VGA Header (Only for IMB-190 / IMB-191)

(10-pin VGA1)

(see p.12 No. 26)



| PIN | Signal Name | PIN | Signal Name | PIN | Signal Name | PIN | Signal Name | PIN | Signal Name |
|-----|-------------|-----|-------------|-----|-------------|-----|-------------|-----|-------------|
| 10 | DDC_DATA | 8 | VSYNC | 6 | GND | 4 | GND | 2 | GND |
| 9 | DDC_CLK | 7 | HSYNC | 5 | BLUE | 3 | GREEN | 1 | RED |

Chapter 3: UEFI SETUP UTILITY

3.1 Introduction

This section explains how to use the UEFI SETUP UTILITY to configure your system. The UEFI chip on the motherboard stores the UEFI SETUP UTILITY. You may run the UEFI SETUP UTILITY when you start up the computer. Please press <F2> or during the Power-On-Self-Test (POST) to enter the UEFI SETUP UTILITY, otherwise, POST will continue with its test routines.

If you wish to enter the UEFI SETUP UTILITY after POST, restart the system by pressing <Ctl> + <Alt> + <Delete>, or by pressing the reset button on the system chassis. You may also restart by turning the system off and then back on.



Because the UEFI software is constantly being updated, the following UEFI setup screens and descriptions are for reference purpose only, and they may not exactly match what you see on your screen.

3.1.1 UEFI Menu Bar

The top of the screen has a menu bar with the following selections:

| | |
|--------------------|---|
| Main | To set up the system time/date information |
| Advanced | To set up the advanced UEFI features |
| H/W Monitor | To display current hardware status |
| Security | To set up the security features |
| Boot | To set up the default system device to locate and load the Operating System |
| Exit | To exit the current screen or the UEFI SETUP UTILITY |

Use <←> key or <→> key to choose among the selections on the menu bar, and then press <Enter> to get into the sub screen. You can also use the mouse to click your required item.

3.1.2 Navigation Keys

Please check the following table for the function description of each navigation key.

| Navigation Key(s) | Function Description |
|-------------------|---|
| ← / → | Moves cursor left or right to select Screens |
| ↑ / ↓ | Moves cursor up or down to select items |
| + / - | To change option for the selected items |
| <Enter> | To bring up the selected screen |
| <F1> | To display the General Help Screen |
| <F7> | Discard changes |
| <F9> | To load optimal default values for all the settings |
| <F10> | To save changes and exit the UEFI SETUP UTILITY |
| <F12> | Print screen |
| <ESC> | To jump to the Exit Screen or exit the current screen |

3.2 Main Screen

When you enter the UEFI SETUP UTILITY, the Main screen will appear and display the system overview.

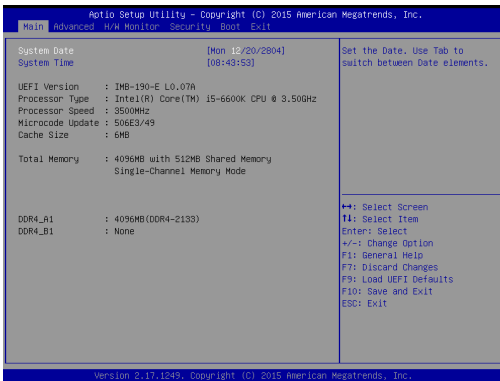

3.3 Advanced Screen

In this section, you may set the configurations for the following items: CPU Configuration, Chipset Configuration, Storage Configuration, AMT Configuration, Super IO Configuration, ACPI Configuration and USB Configuration.

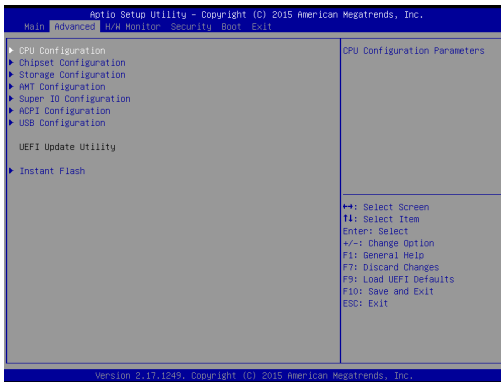

Setting wrong values in this section may cause the system to malfunction.

Instant Flash

Instant Flash is a UEFI flash utility embedded in Flash ROM. This convenient UEFI update tool allows you to update system UEFI without entering operating systems first like MS-DOS or Windows®. Just launch this tool and save the new UEFI file to your USB flash drive, floppy disk or hard drive, then you can update your UEFI only in a few clicks without preparing an additional floppy diskette or other complicated flash utility. Please be noted that the USB flash drive or hard drive must use FAT32/16/12 file system. If you execute Instant Flash utility, the utility will show the UEFI files and their respective information. Select the proper UEFI file to update your UEFI, and reboot your system after UEFI update process completes.

3.3.1 CPU Configuration

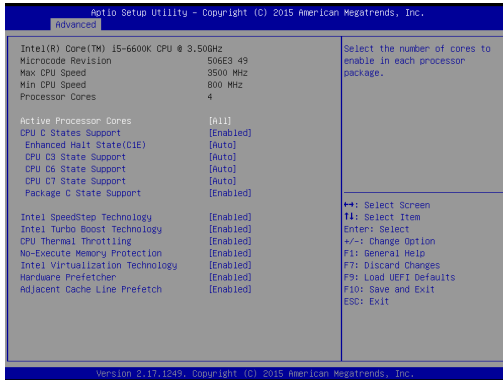

Active Processor Cores

Select the number of cores to enable in each processor package.

CPU C States Support

Enable CPU C States Support for power saving. It is recommended to keep C3, C6 and C7 all enabled for better power saving.

Enhanced Halt State (C1E)

Enable Enhanced Halt State (C1E) for lower power consumption.

CPU C3 State Support

Enable C3 sleep state for lower power consumption.

CPU C6 State Support

Enable C6 deep sleep state for lower power consumption.

CPU C7 State Support

Enable C7 deep sleep state for lower power consumption.

Package C State Support

Enable CPU, PCIe, Memory, Graphics C State Support for power saving.

Intel SpeedStep Technology

Intel SpeedStep technology is Intel's new power saving technology. Processors can switch between multiple frequencies and voltage points to enable power saving. The default value is [Enabled]. Configuration options: [Enabled] and [Disabled]. If you install Windows® 7 / 8 / 8.1 / 10 and want to enable this function, please set this item to [Enabled]. This item will be hidden if the current CPU does not support Intel SpeedStep technology.



Please note that enabling this function may reduce CPU voltage and lead to system stability or compatibility issues with some power supplies. Please set this item to [Disabled] if above issues occur.

Intel Turbo Boost Technology

Use this item to enable or disable Intel Turbo Boost Mode Technology. Turbo Boost Mode allows processor cores to run faster than marked frequency in specific conditions. The default value is [Enabled].

CPU Thermal Throttling

You may select [Enabled] to enable CPU internal thermal control mechanism to keep the CPU from overheating.

No-Execute Memory Protection

No-Execution (NX) Memory Protection Technology is an enhancement to the IA-32 Intel Architecture. An IA-32 processor with “No Execute (NX) Memory Protection” can prevent data pages from being used by malicious software to execute codes. This option will be hidden if the current CPU does not support No-Execute Memory Protection.

Intel Virtualization Technology

When this option is set to [Enabled], a VMM (Virtual Machine Architecture) can utilize the additional hardware capabilities provided by Vanderpool Technology. This option will be hidden if the installed CPU does not support Intel Virtualization Technology.

Hardware Prefetcher

Use this item to turn on/off the MLC streamer prefetcher.

Adjacent Cache Line Prefetch

Use this item to turn on/off prefetching of adjacent cache lines.

3.3.2 Chipset Configuration



Primary Graphics Adapter

This allows you to select [Onboard] or [PCI Express] as the boot graphic adapter priority. The default value is [PCI Express].

Top of Lower usable DRAM

Set the maximum value of TOLUD. Set this item to Dynamic to allow TOLUD to adjust automatically based on the largest MMIO length of the installed graphic controller.

VT-d

Use this to enable or disable Intel® VT-d technology (Intel® Virtualization Technology for Directed I/O). The default value of this feature is [Disabled].

PCIe1 Link Speed

Select the link speed for PCIe1.

Share Memory

Configure the size of memory that is allocated to the integrated graphics processor when the system boots up.

IGPU Multi-Monitor

Select disable to disable the integrated graphics when an external graphics card is installed. Select enable to keep the integrated graphics enabled at all times.

Onboard LAN1

This allows you to enable or disable the Onboard LAN1 feature.

Onboard LAN2

This allows you to enable or disable the Onboard LAN2 feature.

Onboard HD Audio

Select [Auto], [Enabled] or [Disabled] for the onboard HD Audio feature. If you select [Auto], the onboard HD Audio will be disabled when PCI Sound Card is plugged.

Front Panel

Select [HD] or [AC 97] for the onboard HD Audio Front Panel.

Deep Sleep

Mobile platforms support Deep S4/S5 in DC only and desktop platforms support Deep S4/S5 in AC only. The default value is [Disabled].

eDP Panel BackLight Brightness

The default value is [Level 5].

Primary IGFX Boot Display

Use this to select primary internal graphics boot display. The default value is [VBIOS Default].

3.3.3 Storage Configuration

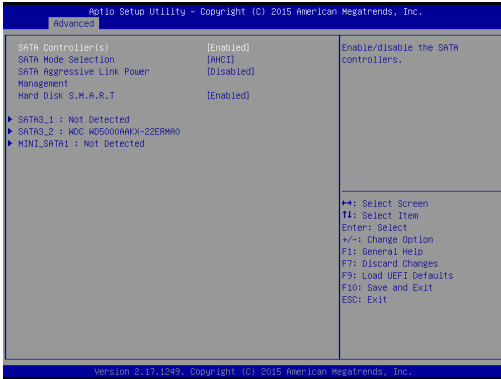

SATA Controller(s)

Use this item to enable or disable the SATA Controller feature.

SATA Mode Selection

Use this to select SATA mode. The default value is [AHCI Mode].



AHCI (Advanced Host Controller Interface) supports NCQ and other new features that will improve SATA disk performance but IDE mode does not have these advantages.

SATA Aggressive Link Power Management

Use this item to configure SATA Aggressive Link Power Management.

Hard Disk S.M.A.R.T.

Use this item to enable or disable the S.M.A.R.T. (Self-Monitoring, Analysis, and Reporting Technology) feature. Configuration options: [Disabled] and [Enabled].

3.3.4 AMT Technology

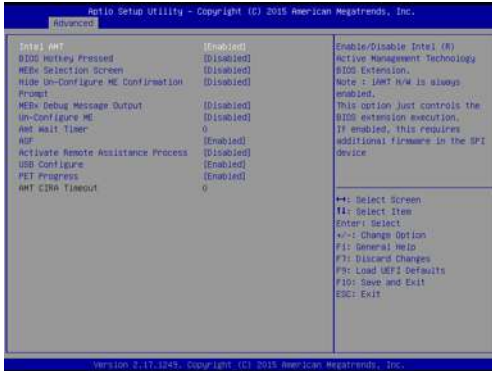

Intel AMT

Use this to enable or disable Intel(R) Active Management Technology BIOS Extension. The default is [Enabled].

BIOS Hotkey Pressed

Use this to enable or disable BIOS hotkey press. The default is [Disabled].

MEBx Selection Screen

Use this to enable or disable MEBx Selection Screen. The default is [Disabled].

Hide Un-Configure ME Confirmation

Hide Un-Configure ME without password confirmation prompt. The default is [Disabled].

MEBx Debug Message Output

Use this to enable or disable MEBx Debug Message Output. The default is [Disabled].

Un-Configure ME

Un-Configure ME without password. The default is [Disabled].

Amt Wait Timer

Set timer to wait before sending ASF_GET_BOOT_OPTIONS.

Disable ME

Set ME to Soft Temporary Disabled. The default is [Disabled].

ASF

Use this to enable or disable Alert Specification Format. The default is [Enabled].

Activate Remote Assistance Process

Trigger CIRA boot. The default is [Disabled].

USB Configure

Use this to enable or disable USB Configure function. The default is [Enabled].

PET Progress

User can enable or disable PET Events progress to receive PET events or not. The default is [Enabled].

3.3.5 Super IO Configuration

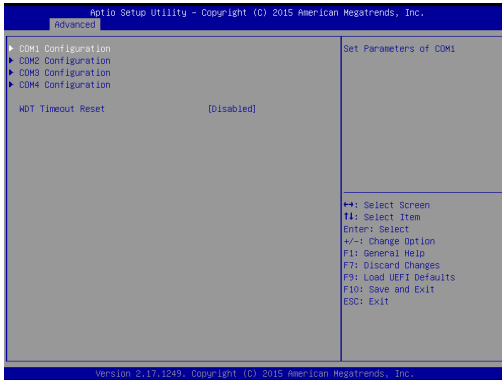

COM1 Configuration

Use this to set parameters of COM1. Select COM1 port type: [RS232], [RS422] or [RS485].

COM2 Configuration

Use this to set parameters of COM2. Select COM2 port type: [RS232], [RS422] or [RS485].

COM3 Configuration

Use this to set parameters of COM3.

COM4 Configuration

Use this to set parameters of COM4.

Watchdog Configuration

Use this to set the Watch Dog Timer.

3.3.6 ACPI Configuration

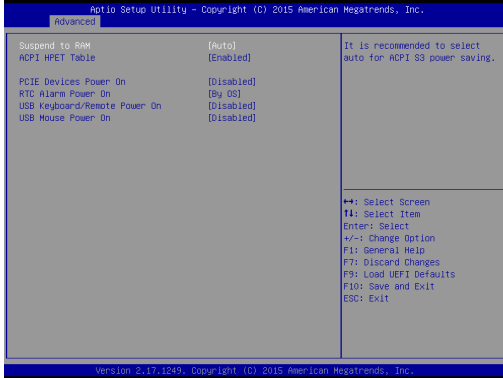

Suspend to RAM

Use this item to select whether to auto-detect or disable the Suspend-to-RAM feature. Select [Auto] will enable this feature if the OS supports it.

ACPI HPET Table

Use this item to enable or disable ACPI HPET Table. The default value is [Enabled]. Please set this option to [Enabled] if you plan to use this motherboard to submit Windows® certification.

PCIE Devices Power On

Use this item to enable or disable PCIE devices to turn on the system from the power-soft-off mode.

RTC Alarm Power On

Use this item to enable or disable RTC (Real Time Clock) to power on the system.

USB Keyboard/Remote Power On

Use this item to enable or disable USB Keyboard/Remote to power on the system.

USB Mouse Power On

Use this item to enable or disable USB Mouse to power on the system.

3.3.7 USB Configuration

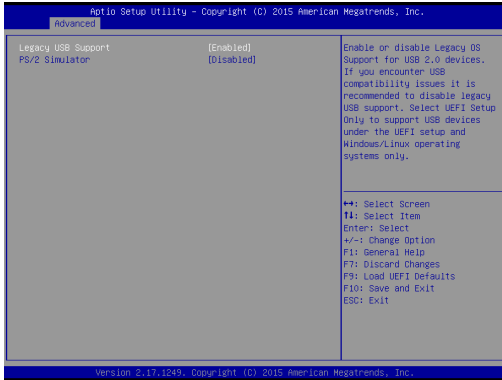

Legacy USB Support

Use this option to select legacy support for USB devices. There are four configuration options: [Enabled], [Auto] and [UEFI Setup Only]. The default value is [Enabled]. Please refer to below descriptions for the details of these four options:

[Enabled] - Enables support for legacy USB.

[Auto] - Enables legacy support if USB devices are connected.

[UEFI Setup Only] - USB devices are allowed to use only under UEFI setup and Windows / Linux OS.

PS/2 Simulator

Enable this item for the complete USB keyboard legacy support for non-USB aware operating system.

3.4 Hardware Health Event Monitoring Screen

In this section, it allows you to monitor the status of the hardware on your system, including the parameters of the CPU temperature, motherboard temperature, CPU fan speed, chassis fan speed, and the critical voltage.

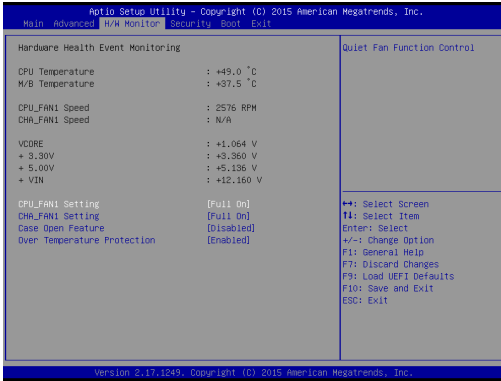

CPU_FAN1 Setting

This allows you to set CPU fan 1's speed. Configuration options: [Full On] and [Automatic Mode]. The default value is [Full On].

CHA_FAN1 Setting

This allows you to set chassis fan 1's speed. Configuration options: [Full On] and [Automatic Mode]. The default value is [Full On].

Case Open Feature

This allows you to enable or disable case open detection feature. The default is value [Disabled].

Clear Status

This option appears only when the case open has been detected. Use this option to keep or clear the record of previous chassis intrusion status.

Over Temperature Protection

Use this to enable or disable Over Temperature Protection. The default value is [Enabled].

3.5 Security Screen

In this section, you may set, change or clear the supervisor/user password for the system.



Supervisor Password

Set or change the password for the administrator account. Only the administrator has authority to change the settings in the UEFI Setup Utility. Leave it blank and press enter to remove the password.

User Password

Set or change the password for the user account. Users are unable to change the settings in the UEFI Setup Utility. Leave it blank and press enter to remove the password.

Secure Boot

Enable to support Windows 8.1 / 8 Secure Boot.

Intel(R) Platform Trust Technology

Enable/disable Intel PTT in ME. Disable this option to use discrete TPM Module.

3.6 Boot Screen

In this section, it will display the available devices on your system for you to configure the boot settings and the boot priority.



Boot From Onboard LAN

Use this item to enable or disable the Boot From Onboard LAN feature.

Setup Prompt Timeout

This shows the number of seconds to wait for setup activation key. 65535(0XFFFF) means indefinite waiting.

Bootup Num-Lock

If this item is set to [On], it will automatically activate the Numeric Lock function after boot-up.

Boot Beep

Select whether the Boot Beep should be turned on or off when the system boots up. Please note that a buzzer is needed.

Full Screen Logo

Use this item to enable or disable OEM Logo. The default value is [Enabled].

CSM (Compatibility Support Module)



CSM

Enable to launch the Compatibility Support Module. Please do not disable unless you're running a WHCK test. If you are using Windows® 8.1 / 8 64-bit and all of your devices support UEFI, you may also disable CSM for faster boot speed.

Launch PXE OpROM Policy

Select UEFI only to run those that support UEFI option ROM only. Select Legacy only to run those that support legacy option ROM only. Do not launch?

Launch Storage OpROM Policy

Select UEFI only to run those that support UEFI option ROM only. Select Legacy only to run those that support legacy option ROM only. Do not launch?

Launch Video OpROM Policy

Select UEFI only to run those that support UEFI option ROM only. Select Legacy only to run those that support legacy option ROM only. Do not launch?

3.7 Exit Screen



Save Changes and Exit

When you select this option, it will pop-out the following message, "Save configuration changes and exit setup?" Select [OK] to save the changes and exit the UEFI SETUP UTILITY.

Discard Changes and Exit

When you select this option, it will pop-out the following message, "Discard changes and exit setup?" Select [OK] to exit the UEFI SETUP UTILITY without saving any changes.

Discard Changes

When you select this option, it will pop-out the following message, "Discard changes?" Select [OK] to discard all changes.

Load UEFI Defaults

Load UEFI default values for all the setup questions. F9 key can be used for this operation.

Launch EFI Shell from filesystem device

Attempts to Launch EFI Shell application (Shell64.efi) from one of the available filesystem devices.

Chapter 4: Software Support

4.1 Install Operating System

This motherboard supports various Microsoft® Windows® operating systems: 10 / 10 64-bit / 8.1 / 8.1 64-bit / 8 / 8 64-bit / 7 / 7 64-bit. Because motherboard settings and hardware options vary, use the setup procedures in this chapter for general reference only. Refer your OS documentation for more information.

4.2 Support CD Information

The Support CD that came with the motherboard contains necessary drivers and useful utilities that enhance the motherboard's features.

4.2.1 Running The Support CD

To begin using the support CD, insert the CD into your CD-ROM drive. The CD automatically displays the Main Menu if "AUTORUN" is enabled in your computer. If the Main Menu did not appear automatically, locate and double click on the file "ASRSETUP.EXE" from the BIN folder in the Support CD to display the menus.

4.2.2 Drivers Menu

The Drivers Menu shows the available device's drivers if the system detects installed devices. Please install the necessary drivers to activate the devices.

4.2.3 Utilities Menu

The Utilities Menu shows the application software that the motherboard supports. Click on a specific item then follow the installation wizard to install it.

4.2.4 Contact Information

If you need to contact ASRock or want to know more about ASRock, you're welcome to visit ASRock's website at <http://www.asrock.com>; or you may contact your dealer for further information.