ASRock[®]

iBOX-210

User Manual

Version 1.0

Published May 2014

Copyright©2014 ASRock Inc. All rights reserved.

Copyright Notice:

No part of this documentation may be reproduced, transcribed, transmitted, or translated in any language, in any form or by any means, except duplication of documentation by the purchaser for backup purpose, without written consent of ASRock Inc.

Products and corporate names appearing in this documentation may or may not be registered trademarks or copyrights of their respective companies, and are used only for identification or explanation and to the owners' benefit, without intent to infringe.

Disclaimer:

Specifications and information contained in this documentation are furnished for informational use only and subject to change without notice, and should not be constructed as a commitment by ASRock. ASRock assumes no responsibility for any errors or omissions that may appear in this documentation.

With respect to the contents of this documentation, ASRock does not provide warranty of any kind, either expressed or implied, including but not limited to the implied warranties or conditions of merchantability or fitness for a particular purpose.

In no event shall ASRock, its directors, officers, employees, or agents be liable for any indirect, special, incidental, or consequential damages (including damages for loss of profits, loss of business, loss of data, interruption of business and the like), even if ASRock has been advised of the possibility of such damages arising from any defect or error in the documentation or product.



This device complies with Part 15 of the FCC Rules. Operation is subject to the following two conditions:

- (1) this device may not cause harmful interference, and
- (2) this device must accept any interference received, including interference that may cause undesired operation.

CALIFORNIA, USA ONLY

The Lithium battery adopted on this motherboard contains Perchlorate, a toxic substance controlled in Perchlorate Best Management Practices (BMP) regulations passed by the California Legislature. When you discard the Lithium battery in California, USA, please follow the related regulations in advance.

“Perchlorate Material-special handling may apply, see www.dtsc.ca.gov/hazardouswaste/perchlorate”

ASRock's Website: www.ASRock.com

The terms HDMI™ and HDMI High-Definition Multimedia Interface, and the HDMI logo are trademarks or registered trademarks of HDMI Licensing LLC in the United States and other countries.



Replaceable batteries

CAUTION

**RISK OF EXPLOSION IF BATTERY IS REPLACED BY AN INCORRECT TYPE.
DISPOSE OF USED BATTERIES ACCORDING TO THE INSTRUCTIONS**

Contact Information

If you need to contact ASRock or want to know more about ASRock, you're welcome to visit ASRock's website at www.ASRock.com; or you may contact your dealer for further information.

ASRock Incorporation

6F., No.37, Sec. 2, Jhongyang S. Rd., Beitou District,

Taipei City 112, Taiwan (R.O.C.)

Contents

| | |
|---|-----------|
| Chapter 1 Introduction | 1 |
| 1.1 Package Contents | 1 |
| 1.2 Product Specifications | 2 |
| 1.3 Block Diagram | 3 |
| Chapter 2 Product Overview | 4 |
| 2.1 Inside View | 4 |
| 2.2 Front View | 5 |
| 2.3 Rear View | 6 |
| Chapter 3 Hardware Installation | 7 |
| 3.1 Removing the Chassis Bottom Cover | 8 |
| 3.2 Installing Memory Modules (SO-DIMM) | 9 |
| 3.3 Installing the 2.5-inch Hard Drive | 10 |
| 3.4 Installing the WiFi module and the WiFi antennas (Optional) | 12 |
| 3.5 Replacing the Chassis Bottom Cover | 14 |
| Chapter 4 Motherboard | 15 |
| 4.1 Motherboard Layout | 15 |
| 4.2 Motherboard Specifications | 17 |
| 4.3 Jumpers Setup | 19 |
| 4.4 Onboard Headers and Connectors | 21 |
| 4.5 Expansion Slots (mini-PCIe and mini-PCIe/mini-SATA Slots) | 26 |

Chapter 1 Introduction

Thank you for purchasing iBOX-210, a reliable embedded box PC produced under ASRock's consistently stringent quality control. It delivers excellent performance with robust design conforming to ASRock's commitment to quality and endurance.



*Because the hardware specifications might be updated, the content of this documentation will be subject to change without notice. In case any modifications of this documentation occur, the updated version will be available on ASRock's website without further notice. If you require technical support related to this product, please visit our website for specific information about the model you are using.
ASRock's Website: www.asrock.com*



The illustrations shown in this manual are examples only, the actual system may differ slightly.

1.1 Package Contents

- iBOX-210
- SBC-210/211 (pre-installed motherboard)
- 1 x SATA 1 to 1 Power Cable
- 4 x HDD Screws (M3x4)
- 1 x WiFi Module Screw (M2x3)
- 1 x Screw for mini-PCIe/mini-SATA slot (M2x3)
- Power Adapter
- User Manual



If any items are missing or appear damaged, contact your authorized dealer.

1.2 Product Specifications

| iBOX-210 | |
|------------------|---|
| Processor System | |
| CPU | Intel® Atom™ Baytrail SoC processor J1900/N2930/E3845/ E3815 Quad/Single Core up to 2GHz |
| Memory | 1 x DDR3L 1333MHz SO-DIMM up to 4 GB |
| Chipset | N/A |
| Graphic | Intel Gen7 |
| LAN Chipset | Realtek RTL8111G |
| Watch Dog | 256 Segments,0,1,2,...255sec/min |
| Rear I/O | |
| Serial Port | 1 x RS232/485/422, 1 x RS232 |
| USB | 2 USB 3.0 ports/2 USB2.0 ports |
| LAN | 1 RJ45 Port for Gbe |
| Vedio output | 1 x VGA output/ 1 x HDMI |
| Audio | Line out |
| Expansion | 1 x mini PCIe /1 x mSATA |
| Storage | |
| Type | 1 x 2.5" HDD/ SSD |
| OS Support | |
| Window 8/7 Linux | |
| Certifications | |
| CE, FCC, Class A | |
| Environmental | |
| Operating Temp | 0°C~50°C |
| Storage Temp | -20°C~80°C |
| Humidity | 10%~90% |
| Mechanical | |
| Material | Top cover -aluminum extrusion/ Base- metal |
| Dimension | 200x134.5x 39mm |
| Weight | 1.3 kg |
| Mounting | mounting bracket (optional) |

* For detailed product information, please visit our website: <http://www.asrock.com>

1.3 Block Diagram

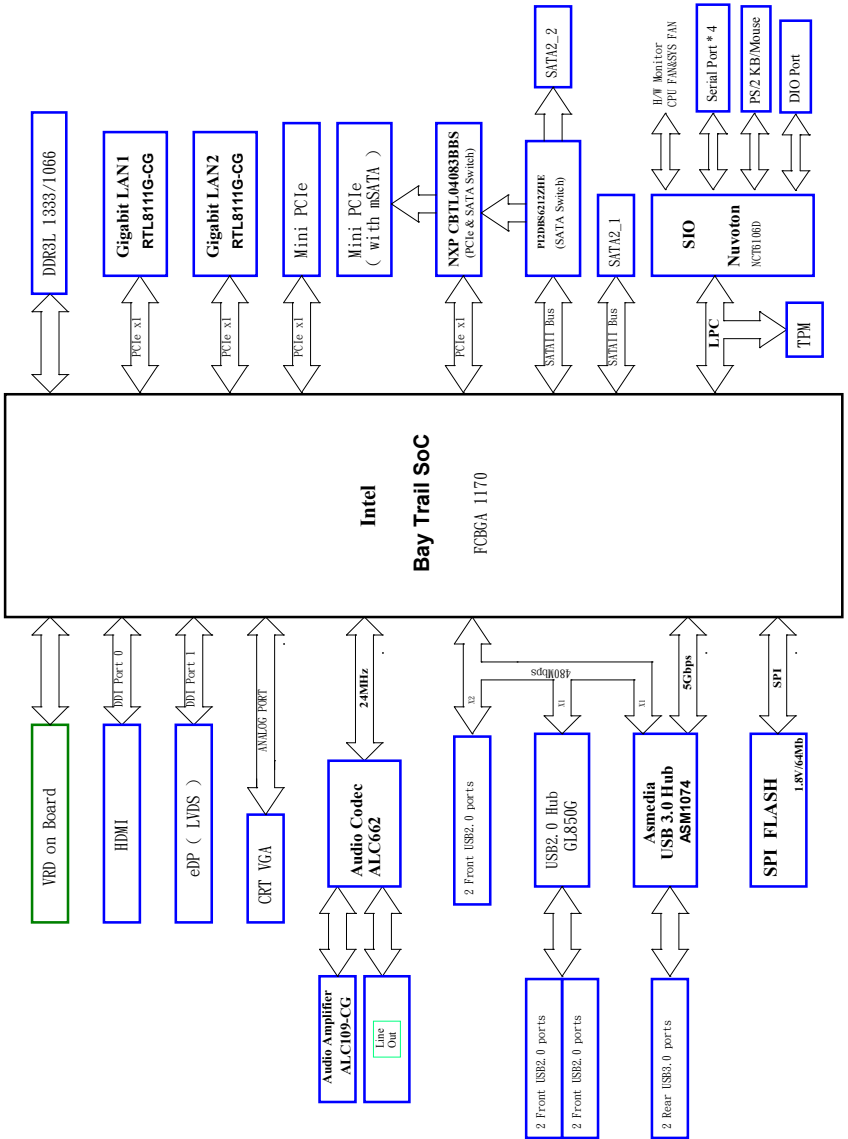

Chapter 2 Product Overview

This chapter provides diagrams showing the location of important components of the iBOX-210.

2.1 Inside View

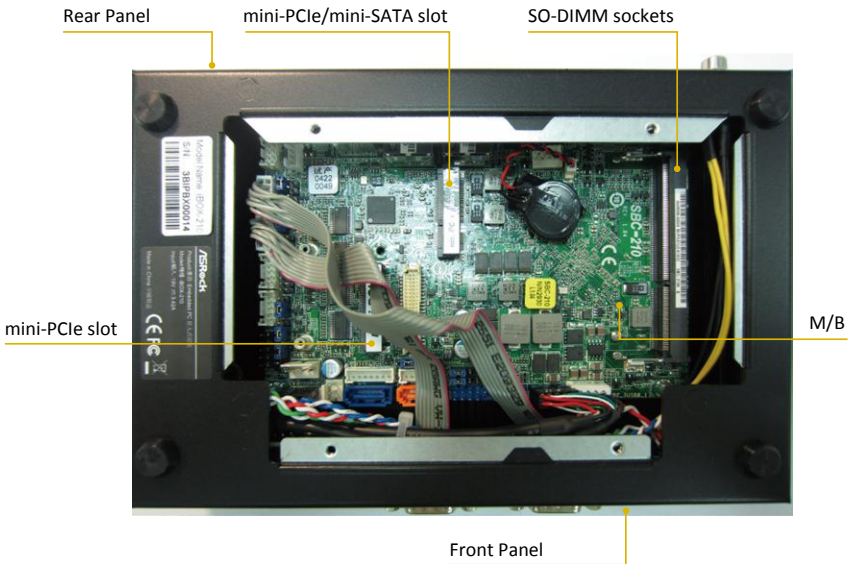

2.2 Front View

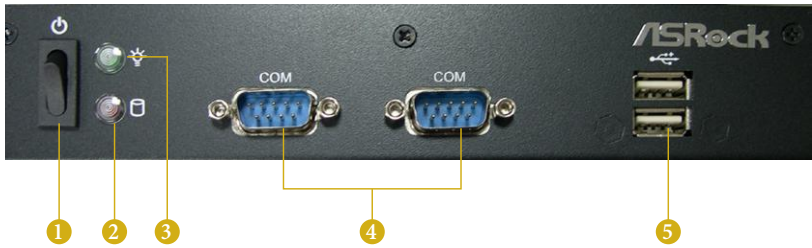

| No. | Description |
|-----|-------------------|
| 1 | On-/off Switch |
| 2 | HDD LED |
| 3 | Power LED |
| 4 | 2 x COM Ports |
| 5 | 2 x USB 2.0 Ports |

Status LED Definitions

| Power LED | |
|-------------|-------------|
| Status | Description |
| Solid Green | Power on |
| Off | Power off |

| HDD Status LED | |
|----------------|-----------------|
| Status | Description |
| Red | HDD installed |
| Off | HDD uninstalled |

2.3 Rear View

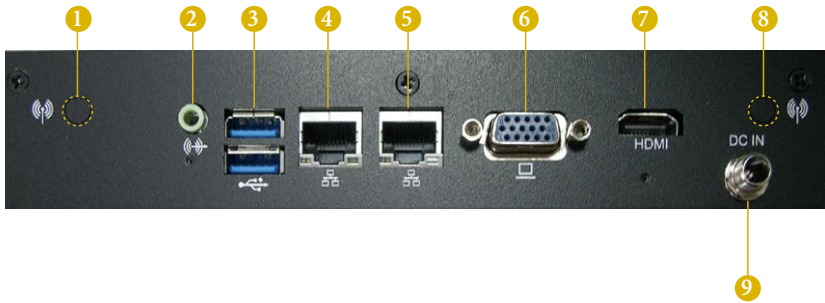

| No. | Description | No. | Description |
|-----|---------------------------|-----|-------------------|
| 1 | Antenna Port | 6 | VGA Port (VGA1) |
| 2 | Line out (Lime) | 7 | HDMI Port (HDMI1) |
| 3 | 2 x USB 3.0 Ports (USB01) | 8 | Antenna Port |
| 4 | LAN RJ-45 Port (LAN1)* | 9 | DC Jack (DC IN) |
| 5 | LAN RJ-45 Port (LAN2)* | | |

* There are two LEDs on each LAN port. Please refer to the table below for the LAN port LED indications.

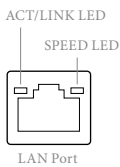

| Activity / Link LED | | Speed LED | |
|---------------------|---------------|-----------|--------------------|
| Status | Description | Status | Description |
| Off | No Link | Off | 10Mbps connection |
| Off | Data Activity | Orange | 100Mbps connection |
| On | Link | Green | 1Gbps connection |

Chapter 3 Hardware Installation

This chapter provides step-by-step procedures on how to install components.

Installation Procedures

- 1 Removing the chassis bottom cover
- 2 Installing the memory modules (SO-DIMM)
- 3 Installing the 2.5-inch hard drive
- 4 Installing the WiFi module and the WiFi antennas (**Optional**)
- 5 Replacing the chassis top cover

After making sure that you have properly connected the power supply and all the necessary peripherals, power on the system.

3.1 Removing the Chassis Bottom Cover

1. Remove the four screws on the bottom case.
2. Lift up and remove the top cover.

1



3.2 Installing Memory Modules (SO-DIMM)

This motherboard provides two 204-pin DDR3 (Double Data Rate 3) SO-DIMM slots. Please install the SO-DIMM module into the DDR3_A2 for the first priority.



It is not allowed to install a DDR or DDR2 memory module into a DDR3 slot; otherwise, this motherboard and SO-DIMM may be damaged.



The SO-DIMM only fits in one correct orientation. It will cause permanent damage to the motherboard and the SO-DIMM if you force the SO-DIMM into the slot at incorrect orientation.

1

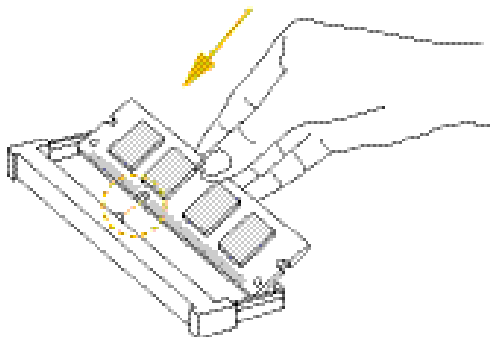

2

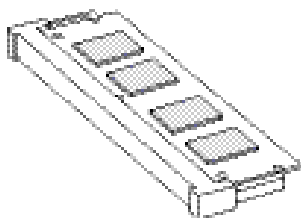

3.3 Installing the 2.5-inch Hard Drive

1. Attach the HDD onto the bottom cover with the printed circuit board side facing down. Carefully align the mounting holes in the hard drive and the bottom cover.
2. Secure the hard drive into the place using the four screws.
3. Attach one end of the SATA 1 to 1 Power Cable to the hard drive.

1



2

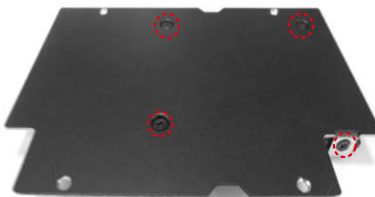

3

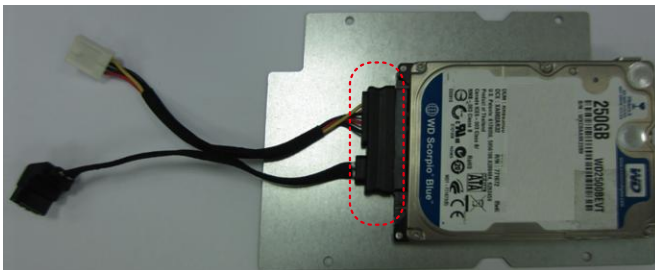

4. Attach the SATA data cable and power cable to the motherboard.

4

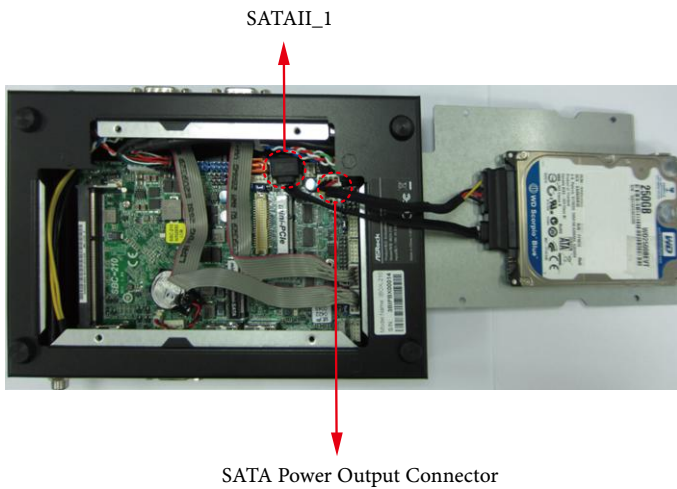

3.4 Installing the WiFi module and the WiFi antennas (Optional)

1. Insert the WiFi Module Card into the mini PCI Express slot (MINI_PCIE1).
2. Tighten the screw that holds the card in place.
3. Attach the SMA Wi-Fi Antenna Cables to the WiFi Module.

1



2



3

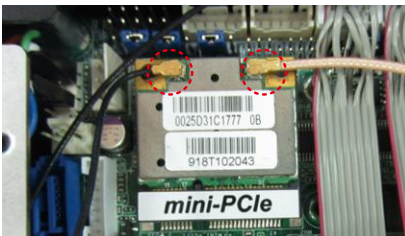

4. Insert the RP-SMA Wi-Fi Antenna Connectors to the antenna ports on the rear panel. Then fasten the screw nuts to secure the antenna connectors.
5. Connect the two WiFi 2.4/5 GHz Antennas to the antenna connectors. Turn the antenna clockwise until it is securely connected.
6. Set the WiFi 2.4/5 GHz Antenna at 90-degree angle.
*You may need to adjust the direction of the antenna for a stronger signal.

4



5



6



3.5 Replacing the Chassis Bottom Cover

1. Replace the top cover.
2. Secure the four screws at the bottom.

1

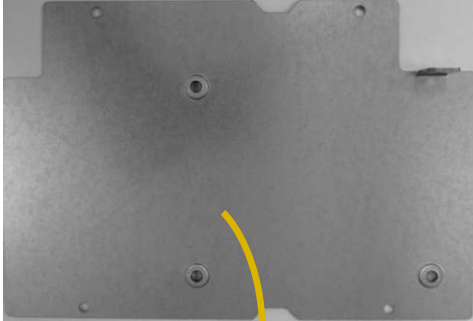

2



Chapter 4 Motherboard

4.1 Motherboard Layout

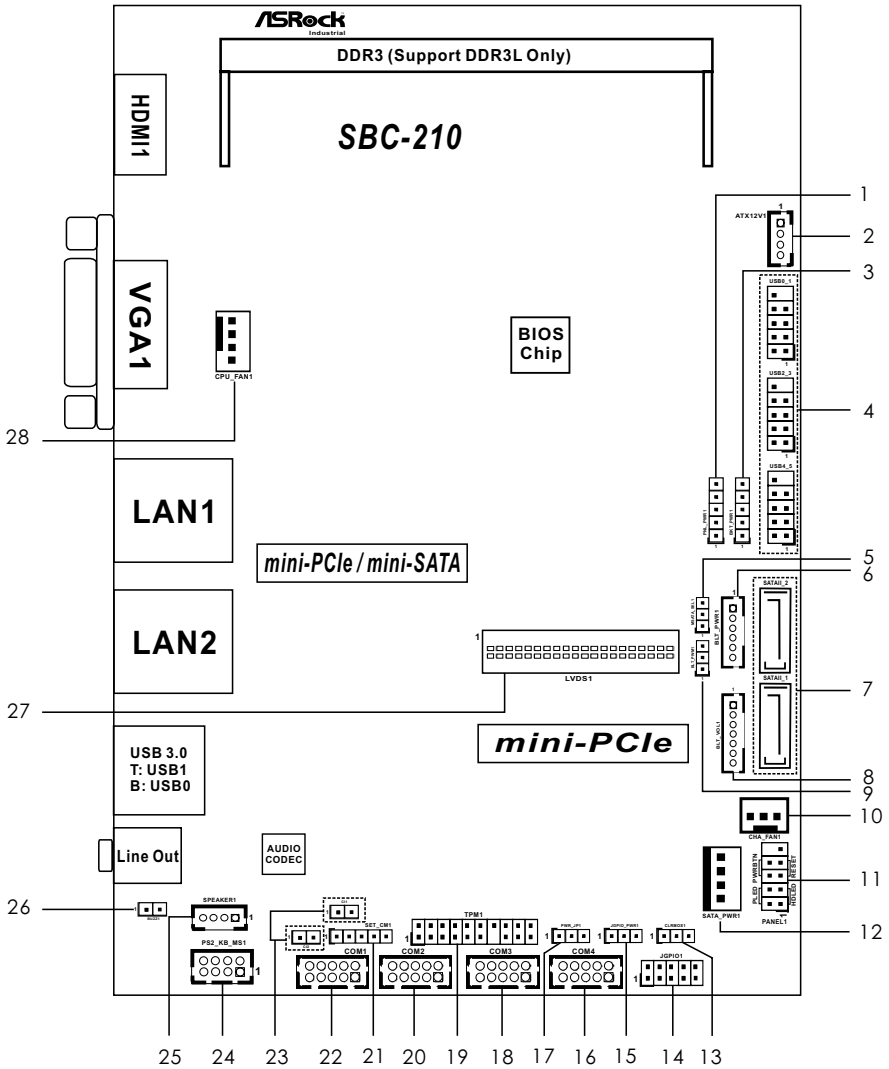

| No. | Description |
|-----|---|
| 1 | Panel Power Selection (PNL_PWR1) |
| 2 | ATX Power Connector |
| 3 | Backlight Power Selection (BKT_PWR1) |
| 4 | USB2.0 Headers (USB0_1, USB2_3, USB4_5) |
| 5 | mSATA Selection |
| 6 | Inverter Power Control Wafer (BLT_PWR1) |
| 7 | SATA2 Connectors (SATAII_1, SATAII_2) |
| 8 | Backlight & Amp Volume Control (BLT_VOL1) |
| 9 | Backlight Control Level (BLT_PWM1) |
| 10 | 3-Pin Chassis FAN Connector |
| 11 | System Panel Header |
| 12 | SATA Power Output Connector |
| 13 | Clear CMOS Header |
| 14 | Digital Input / Output Pin Header |
| 15 | Digital Input / Output Power Select |
| 16 | COM Port Header (COM4) |
| 17 | ATX/AT Mode Selection |
| 18 | COM Port Header (COM3) |
| 19 | TPM Header |
| 20 | COM Port Header (COM2) |
| 21 | SET_CM1 |
| 22 | COM Port Header (COM1) |
| 23 | Chassis Intrusion Headers (CI1, CI2) |
| 24 | PS2_KB_MS1 |
| 25 | 3W Audio AMP Output Wafer |
| 26 | 2-Pin Buzzer Header |
| 27 | LVDS Panel Connector |
| 28 | 4-Pin CPU FAN Connector |

4.2 Motherboard Specifications

| | | |
|-------------------------|------------------------|---|
| Form Factor | Dimensions | 3.5" SBC (5.8-in x 4.0-in) / (146 x 102 mm) |
| Processor System | CPU | Intel® new Atom™ Baytrail-M/D/E Series |
| | Core Number | 4 |
| | Max Speed | (By CPU) |
| | Cache | (By CPU) |
| | Chipset | N/A |
| Expansion Slot | BIOS | UEFI |
| | PCI | 0 |
| | Mini-PCIe | 1 (Half Size) + 1 (Full Size) shared with mSATA |
| | mSATA | 1 (Full Size) shared with SATAII_2 |
| | PCIe | 0 |
| Memory | CFast Card Socket | 0 |
| | Technology | Single Channel DDR3L 1066/1333 MHz SDRAM |
| | Max. | 4GB |
| Graphics | Socket | 1 x SO-DIMM |
| | Controller | Intel® Gen7 Intel Graphics DX 11, OGL3.2 |
| | VRAM | Shared Memory |
| | VGA | Supports max. resolution 1920 x 1200 |
| | LVDS | Dual channel 24-bit, max resolution 1920 x 1200 @60Hz |
| | HDMI | Supports HDMI 1.4a, max resolution 1920 x 1200 |
| | DVI | N/A |
| | DisplayPort | N/A |
| Multi Display | Yes (Dual Display) | |
| Ethernet | Ethernet | 10/100/1000 Mbps |
| | Controller | GbE LAN: Realtek RTL8111G-CG |
| | Connector | 2 x RJ-45 |
| SATA | Max Data Transfer Rate | SATA2 (3.0Gb/s) |
| Rear I/O | VGA | 1 |
| | DVI | 0 |
| | HDMI | 1 |
| | DisplayPort | 0 |
| | Ethernet | 2 |
| | USB | 2 x USB 3.0 compliant |
| | Audio | 1 (Line out) |
| | Serial | 0 |
| PS/2 | 0 | |

| | | |
|---------------------------|-----------------------|---|
| Internal Connector | USB | 6 (3*2.54 pitch header USB 2.0 compliant) |
| | LVDS/Inverter | 1/1 |
| | VGA | 0 |
| | Serial | 4 (RS-232) |
| | SATA | 2x SATA2 (3.0Gb/s) (SATAII_2 is shared with mSATA) |
| | Parallel | 0 |
| | IrDA | 0 |
| | GPIO 8-bit | 4 x GPI + 4 x GPO |
| | SATA PWR Output Con | 1 |
| | Speaker Header | 1 |
| | Watchdog Timer | Output |
| Interval | | 256 segments, 0,1,2...255sec/min |
| Power Requirements | Input PWR | 9-36V DC-In using 4-pin ATX PWR Con |
| | Power On | AT/ATX Supported AT: Directly PWR on as power input ready ATX: Press button to PWR on after power input ready |
| Environment | Temperature | 0°C – 60°C |

* For detailed product information, please visit our website: <http://www.asrock.com>

4.3 Jumpers Setup

The illustration shows how jumpers are setup. When the jumper cap is placed on the pins, the jumper is “Short”. If no jumper cap is placed on the pins, the jumper is “Open”. The illustration shows a 3-pin jumper whose pin1 and pin2 are “Short” when a jumper cap is placed on these 2 pins.

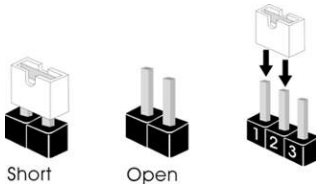

Clear CMOS Jumper
(CLRCMOS1)
(see p.15, No. 13)



CLRCMOS1 allows you to clear the data in CMOS. To clear and reset the system parameters to default setup, please turn off the computer and unplug the power cord from the power supply. After waiting for 15 seconds, use a jumper cap to short pin2 and pin3 on CLRCMOS1 for 5 seconds. However, please do not clear the CMOS right after you update the BIOS. If you need to clear the CMOS when you just finish updating the BIOS, you must boot up the system first, and then shut it down before you do the clear-CMOS action. Please be noted that the password, date, time, and user default profile will be cleared only if the CMOS battery is removed.

Digital Input/Output
PWR Select
(3-pin JGPIO_
PWR1)
(see p.15, No. 5)



1-2 : +12V
2-3 : +5V

ATX/AT Mode
Selection
(3-pin PWR_JP1)
(see p.15, No. 17)



1-2: AT Mode
2-3: ATX Mode

Panel Power
Selection (LCD_
VCC)
(5-pin PNL_PWR1)
(see p.15, No. 1)



Use this to set up the VDD
power of the LVDS connector.
1-2: +3V
2-3: +5V
3-4: +5V
4-5: +12V

Backlight Power Selection
(LCD_BLT_VCC)
(5-pin BKT_PWR1)
(see p.15 No. 3)



Use this to set up the backlight
power of the LVDS connector.
1-2: +5V
2-3: +12V
3-4: +12V
4-5: DC_IN Power

Backlight Control Level
(3-pin BLT_PWM1)
(see p.15 No. 9)



1-2: +3V
2-3: +5V

COM Port PWR Setting
Header
(5-pin SET_CM1)
(see p.15 No. 21)



1-2: +12V
2-3: +5V
3-4: +5V
4-5: N/A

mSATA Selection
(3-pin MSATA_SEL1)
(see p.15 No. 5)



1-2: SATAII_2 + mini-PCIe
2-3: mSATA, SATAII_2 no
function

4.4 Onboard Headers and Connectors



Onboard headers and connectors are NOT jumpers. Do NOT place jumper caps over these headers and connectors. Placing jumper caps over the headers and connectors will cause permanent damage to the motherboard.

SATA2 Connectors
(SATAII_1, SATAII_2)
(see p.15, No. 7)



These two Serial ATA2 (SATA2) connectors support SATA data cables for internal storage devices. The current SATA2 interface allows up to 3.0 Gb/s data transfer rate.

USB 2.0 Headers
(9-pin USB0_1, USB2_3,
USB4_5)
(see p.15 No. 4)

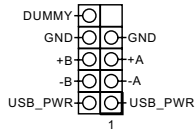

There are three USB 2.0 headers on this motherboard.

System Panel Header
(9-pin PANEL1)
(see p.15 No. 11)

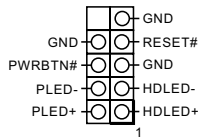

This header accommodates several system front panel functions.



PWRBTN (Power Switch):

Connect to the power switch on the chassis front panel. You may configure the way to turn off your system using the power switch.

RESET (Reset Switch):

Connect to the reset switch on the chassis front panel. Press the reset switch to restart the computer if the computer freezes and fails to perform a normal restart.

PLED (System Power LED):

Connect to the power status indicator on the chassis front panel. The LED is on when the system is operating. The LED keeps blinking when the system is in S3 sleep state. The LED is off when the system is in S4 sleep state or powered off (S5).

HDLED (Hard Drive Activity LED):

Connect to the hard drive activity LED on the chassis front panel. The LED is on when the hard drive is reading or writing data.

The front panel design may differ by chassis. A front panel module mainly consists of power switch, reset switch, power LED, hard drive activity LED, speaker and etc. When connecting your chassis front panel module to this header, make sure the wire assignments and the pin assignments are matched correctly.

3W Audio AMP Output
Wafer
(4-pin SPEAKER1)
(see p.15 No. 25)

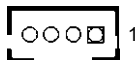

| PIN | Signal Name |
|-----|-------------|
| 1 | SPK L- |
| 2 | SPK L+ |
| 3 | SPK R+ |
| 4 | SPK R- |

Chassis Fan Connector
(3-pin CHA_FAN1)
(see p.15 No. 10)

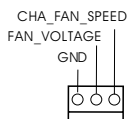

Please connect the fan cable to the fan connector and match the black wire to the ground pin.

CPU Fan Connector
(4-pin CPU_FAN1)
(see p.15 No. 28)

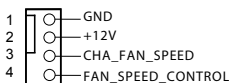

Please connect the CPU fan cable to the connector and match the black wire to the ground pin.



*Though this motherboard provides 4-Pin CPU fan (Quiet Fan) support, the 3-Pin CPU fan still can work successfully even without the fan speed control function.
If you plan to connect the 3-Pin CPU fan to the CPU fan connector on this motherboard, please connect it to Pin 1-3.*

Pin 1-3 Connected ←

3-Pin Fan Installation



ATX Power Connector
(Input 9V-36V)
(4-pin ATX12V1)
(see p.15 No. 2)



Please connect a DC power supply (9V-36V) to this connector.
1-4 : GND
2-3 : DC Input

SATA Power Output
Connector
(4-pin SATA_PWR1)
(see p.15 No. 12)

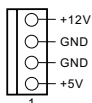

COM Port Headers

(10-pin COM1)

(see p.15 No. 22)

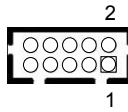

(10-pin COM2)

(see p.15 No. 20)

| PIN | Signal Name | PIN | Signal Name | PIN | Signal Name | PIN | Signal Name | PIN | Signal Name |
|-----|-------------|-----|-------------|-----|-------------|-----|-------------|-----|-------------|
| 10 | DUMMY | 8 | CCTS# | 6 | DDSR# | 4 | DDTR# | 2 | RRXD |
| 9 | DUMMY | 7 | RRTS# | 5 | GND | 3 | TTXD | 1 | DDCD# |

(10-pin COM3)

(see p.15 No. 18)

(10-pin COM4)

(see p.15 No. 16)



This motherboard supports RS232/422/485 on COM1 port. Please refer to below table for the pin definition. In addition, COM1 port (RS232/422/485) can be adjusted in BIOS setup utility > Advanced Screen > Super IO Configuration. You may refer to page 29 for details.

COM1 Port Pin Definition

| PIN | RS232 | RS422 | RS485 |
|-----|-------------|-------|-------|
| 1 | DCD | TX- | RTX- |
| 2 | RXD | RX+ | N/A |
| 3 | TXD | TX+ | RTX+ |
| 4 | DTR | RX- | N/A |
| 5 | GND | GND | GND |
| 6 | DSR | N/A | N/A |
| 7 | RTS | N/A | N/A |
| 8 | CTS | N/A | N/A |
| 9 | NA/+5V/+12V | N/A | N/A |

LVDS Panel

Connector

(40-pin LVDS1)

(see p.15, No. 27)

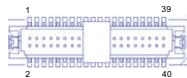

| PIN | Signal Name | PIN | Signal Name |
|-----|-------------------|-----|-------------------|
| 2 | LCD_VCC | 1 | LCD_VCC |
| 4 | LDDC_CLK | 3 | +3V |
| 6 | LVDS_A_ DATA0# | 5 | LDDC_DATA |
| 8 | GND | 7 | LVDS_A_ DATA0 |
| 10 | LVDS_A_ DATA1 | 9 | LVDS_A_ DATA1# |
| 12 | LVDS_A_ DATA2# | 11 | GND |

| PIN | Signal Name | PIN | Signal Name |
|-----|----------------|-----|----------------|
| 14 | GND | 13 | LVDS_A_ DATA2 |
| 16 | LVDS_A_ DATA3 | 15 | LVDS_A_ DATA3# |
| 18 | LVDS_A_CLK# | 17 | GND |
| 20 | GND | 19 | LVDS_A_CLK |
| 22 | LVDS_B_ DATA0 | 21 | LVDS_B_ DATA0# |
| 24 | LVDS_B_ DATA1# | 23 | GND |
| 26 | GND | 25 | LVDS_B_ DATA1 |
| 28 | LVDS_B_ DATA2 | 27 | LVDS_B_ DATA2# |
| 30 | LVDS_B_ DATA3# | 29 | DPLVDD_EN |
| 32 | GND | 31 | LVDS_B_ DATA3 |
| 34 | LVDS_B_CLK | 33 | LVDS_B_CLK# |
| 36 | CON_LBKLT_ EN | 35 | GND |
| 38 | LCD_BLT_VCC | 37 | CON_LBKLT_ CTL |
| 40 | LCD_BLT_VCC | 39 | LCD_BLT_VCC |

Digital Input/Output Pin Header
(10-pin JGPIO1)
(see p.15 No. 14)

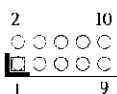

| PIN | Signal Name | PIN | Signal Name |
|-----|-------------|-----|-------------|
| 1 | SIO_GP24 | 2 | SIO_GP20 |
| 3 | SIO_GP25 | 4 | SIO_GP21 |
| 5 | SIO_GP26 | 6 | SIO_GP22 |
| 7 | SIO_GP27 | 8 | SIO_GP23 |
| 9 | JGPIO_PWR | 10 | GND |

PS2_KB_MS1
(8-pin PS2_KB_MS1)
(see p.15 No. 24)

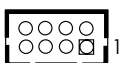

| PIN | Signal Name | PIN | Signal Name | PIN | Signal Name | PIN | Signal Name |
|-----|-------------|-----|-------------|-----|-------------|-----|-------------|
| 8 | GND | 6 | GND | 4 | +5V STANDBY | 2 | +5V STANDBY |
| 7 | MSCLK | 5 | MSDATA | 3 | KBDATA | 1 | KBCLK |

Backlight & Amp Volume
Control
(7-pin BLT_VOL1)
(see p.15 No. 8)

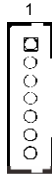

| PIN | Signal Name |
|-----|-------------|
| 1 | GPIO_VOL_UP |
| 2 | GPIO_VOL_DW |
| 3 | PWRDN |
| 4 | GPIO_BLT_UP |
| 5 | GPIO_BLT_DW |
| 6 | GND |
| 7 | GND |

TPM Header
(17-pin TPM1)
(see p.15 No. 19)

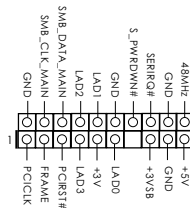

This connector supports Trusted Platform Module (TPM) system, which can securely store keys, digital certificates, passwords, and data. A TPM system also helps enhance network security, protects digital identities, and ensures platform integrity.

Chassis Intrusion Headers
(2-pin CI1, CI2)
(see p.15 No. 23)



This motherboard supports CASE OPEN detection feature that detects if the chassis cover has been removed. This feature requires a chassis with chassis intrusion detection design.

Buzzer Header
(2-pin BUZZ1)
(see p.15 No. 26)



4.5 Expansion Slots (mini-PCIe and mini-PCIe/mini-SATA Slots)

There is 1 mini-PCIe slot and 1 mini-PCIe/mini-SATA slot on this motherboard.



Before installing an expansion card, please make sure that the power supply is switched off or the power cord is unplugged. Please read the documentation of the expansion card and make necessary hardware settings for the card before you start the installation.

mini-PCIe slot:

MINI_PCIE1 (mini-PCIe slot; half size) is used for WiFi module.

mini-PCIe/mini-SATA slot:

MINI_PCIE2 (mini-PCIe/mini-SATA slot; full size) is used for PCI Express mini cards or mSATA cards.