

# 12.1" LCD Open frame SAW Touch Monitor (the Dust-proof Type)

## User Guide

Rev2.0

Model: KOT-0121US-SA6BP



Shenzhen K&JAD Technology Co., Ltd

[www.keetouch.com](http://www.keetouch.com)

Dec. 2010

# Table of Contents

## Chapter 1

### Introduction

1.1 Product Description .....	3
1.2 About the Product .....	3

## Chapter 2

### Installation and Setup

2.1 Unpacking Your Touchmonitor .....	4
2.2 Product Overview .....	5
2.3 Attaching the L-bracket .....	5
2.4 VESA Mounting Interface.....	6
2.5 Interface Connection .....	7
2.6 Installing the Driver Software and Calibration .....	8
2.6.1 Installing the Driver Software .....	8
2.6.2 Calibration.....	9

## Appendix A

Specification .....	11
Mechanical Dimensions .....	12

## Appendix B

Typical Application.....	13
How to contact us.....	14

# Chapter 1

## INTRODUCTION

### 1.1 Product Description

Keetouch's 12.1" LCD touch monitors have a long-lasting product cycle because the enclosure is controlled by Keetouch's specifications. Future panel improvements are therefore possible without external changes. The KOT-0121US-SA6BP integrate with the Keetouch's SAW technology touchscreen.

### 1.2 About the Product

Your LCD openframe touchmonitor is a 12.1" SXGA TFT color display with the following features:

- Long lasting product cycle-enclosure controlled by Keetouch specifications
- Future generation panels phased-in without external changes
- High quality panel with high brightness,high contrast ratio and broad viewing angle
- Multiple mounting options including rear-mount ,VESA mount, horizontal or vertical bracket-mount
- Keetouch's SAW technology on pure glass for the ultimate in image quality
- Dual USB and RS232 touch interface
- Worldwide agency approvals

For full Product Specifications refer to Appendix A.

# Chapter 2

## **INSTALLATION AND SETUP**

This chapter discusses how to install your LCD touchmonitor and how to install the driver software.

### 2.1 Unpacking Your Touchmonitor

Check that the following 9 items are present and in good condition:

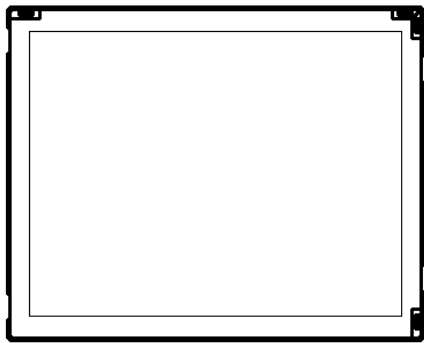

One Touchmonitor

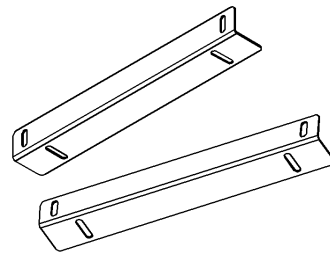

Two L-brackets

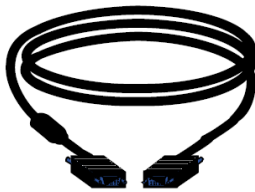

One Video cable

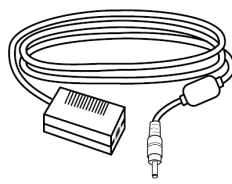

One Brick power supply

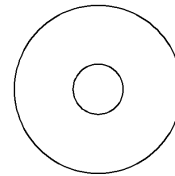

One Driver software CD

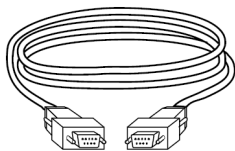

One Serial cable

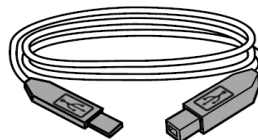

One USB cable



Eight M4 Screws and Washers

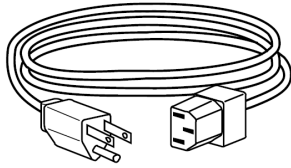

One Power cable US/Canada

OR

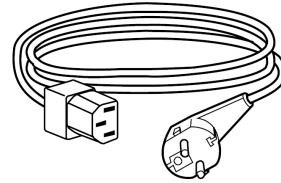

One European power cable

## 2.2 Product Overview

**Main Unit**

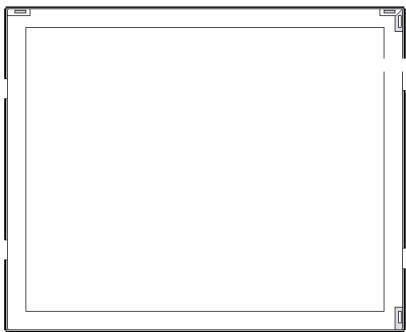

**Rear View**

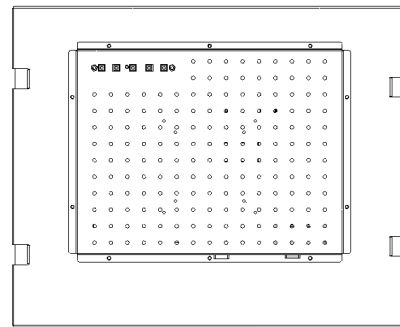

**Side View**



**Bottom View**

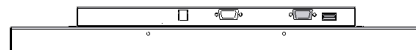

## 2.3 Attaching the L-Brackets

**NOTE: You will need a screwdriver to attach the L-brackets.**

To attach the L-brackets:

- 1 Lay the monitor face down.
- 2 Place the long end of the L-bracket against the side of touchmonitor. Line up the two holes of the L-bracket with the two holes of the touchmonitor.
- 3 Place two M4 screws in the holes and with the screwdriver, screw them in to secure the bracket.
- 4 Repeat steps 2 and 3 to attach the other L-bracket to the other side of the touchmonitor.

**NOTE: The way to attach the L-brackets has two options, See the illustration below:**

**Option 1 (L-brackets to the left and right sides)**

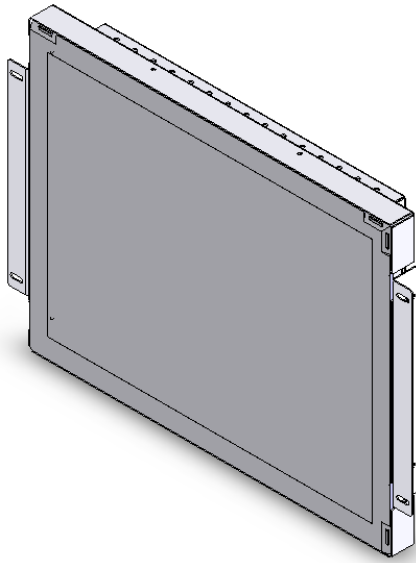

**Option 2 (L-brackets to the up and down sides)**

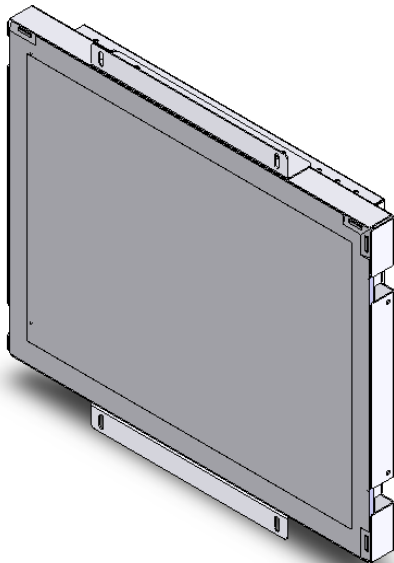

## 2.4 VESA Mounting Interface

Your touchmonitor conforms to the VESA Flat Panel Monitor Physical Mounting Interface (FPMPMITM) Standard which defines a physical mounting interface for flat panel monitors, and corresponding standards for flat panel monitor mounting devices, such as wall and table arms.

Your monitor has standard VESA mounting holes on the rear of the unit. The holes are spaced at 75mm and 100mm standard.

**NOTE: Do not penetrate the M4 screw into the monitor more than 5mm.**

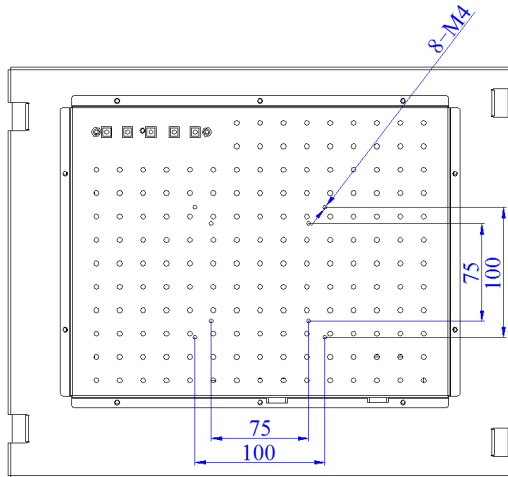

## 2.5 Interface Connection

**Note: Before connecting the cables to your touchmonitor and PC, be sure that the computer and touchmonitor are turned off.**

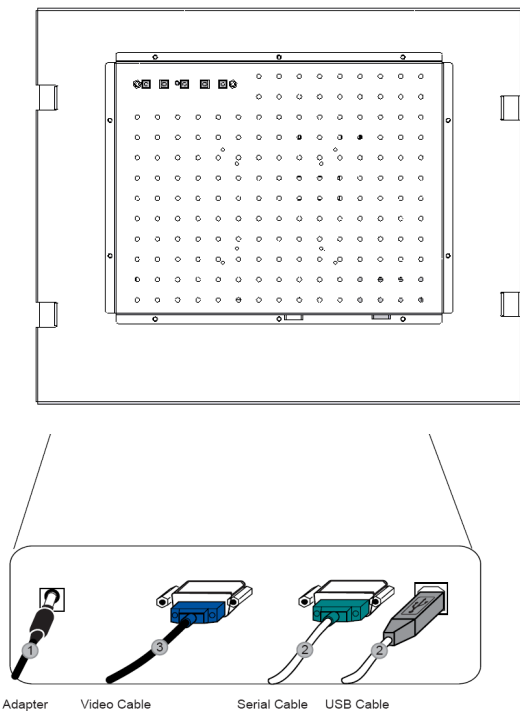

1. Connect one end of either the **serial (RS232) cable** or the **USB cable**(but not both) to the rear side of the computer and the other end to the LCD monitor. Tighten by turning the two thumb screws clockwise to ensure proper grounding ( USB cable does not have thumb screws).
2. Connect one end of the **video cable** to the rear side of computer and the other to the LCD monitor. Tighten by turning the two thumb screws clockwise to ensure proper grounding.
3. Connect one end of the **power adapter** to the monitor and the other end to the connector of the power cord.
4. Press the **power button** on the rear panel to turn the monitor power on.

**NOTE:** The touchmonitor should be integrated according to the above process, if not may result in the touchmonitor working abnormally.

## 2.6 Installing the Driver Software and Calibration

Keetouch TouchSystems provides driver software that allows your touchmonitor to work with your computer. Drivers are located on the enclosed CD-ROM for the following operating systems:

- Windows XP
- Windows 2000
- Linux

The latest versions of drivers and driver information for other operating systems are available on the Keetouch TouchSystems web site at [www.Keetouchtouch.com](http://www.Keetouchtouch.com).

Your Keetouch touchmonitor is Plug-and-Play compliant. Information on the video capabilities of your touchmonitor is sent to your video display adapter when Windows starts. If Windows detects your touchmonitor, follow the instructions on the screen to install a generic Plug-and-Play monitor.

### 2.6.1 Installing the Driver Software

double click the file of "Setup.exe" in the folder , the Windows will flip Dialog Box as follow:

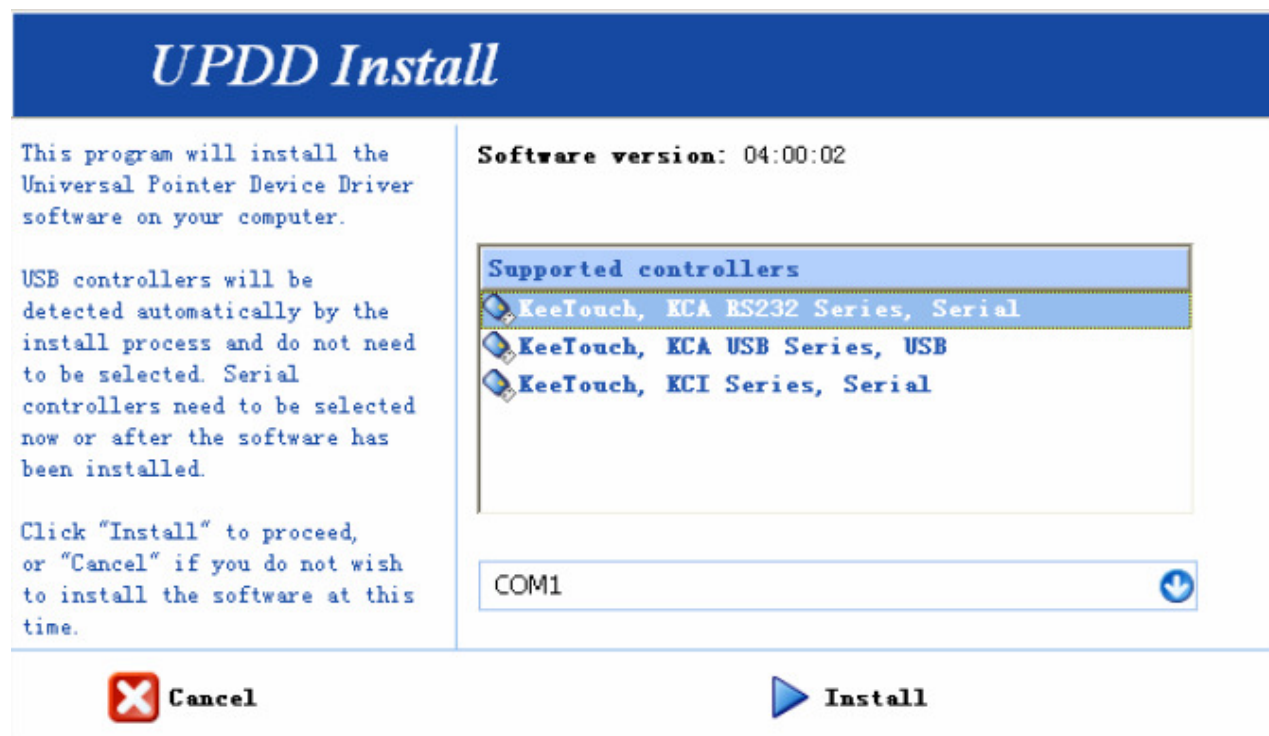

**NOTE:**Your touchmonitor have dual USB and Serial(RS232) touch interface port, Depending upon whether you connected the USB communication cable or the Serial(RS232) communication cable, you should install only the USB driver or the Serial(RS232) driver. Install the USB driver, please chose the "KeeTouch, KCA USB Series, USB";Install the Serial(RS232) driver, please chose "theKeeTouch,KCA RS232 Series,Serial".



After selecting the proper interface, click the Install button to start installing the driver as following.

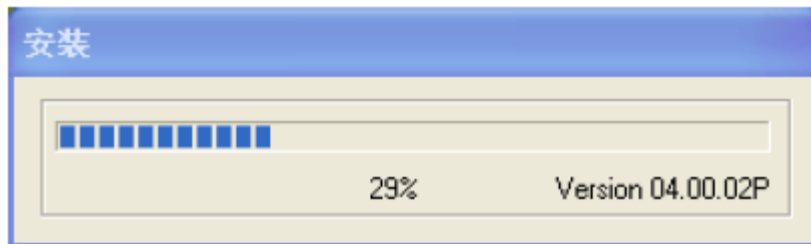

Installation successfully as following:

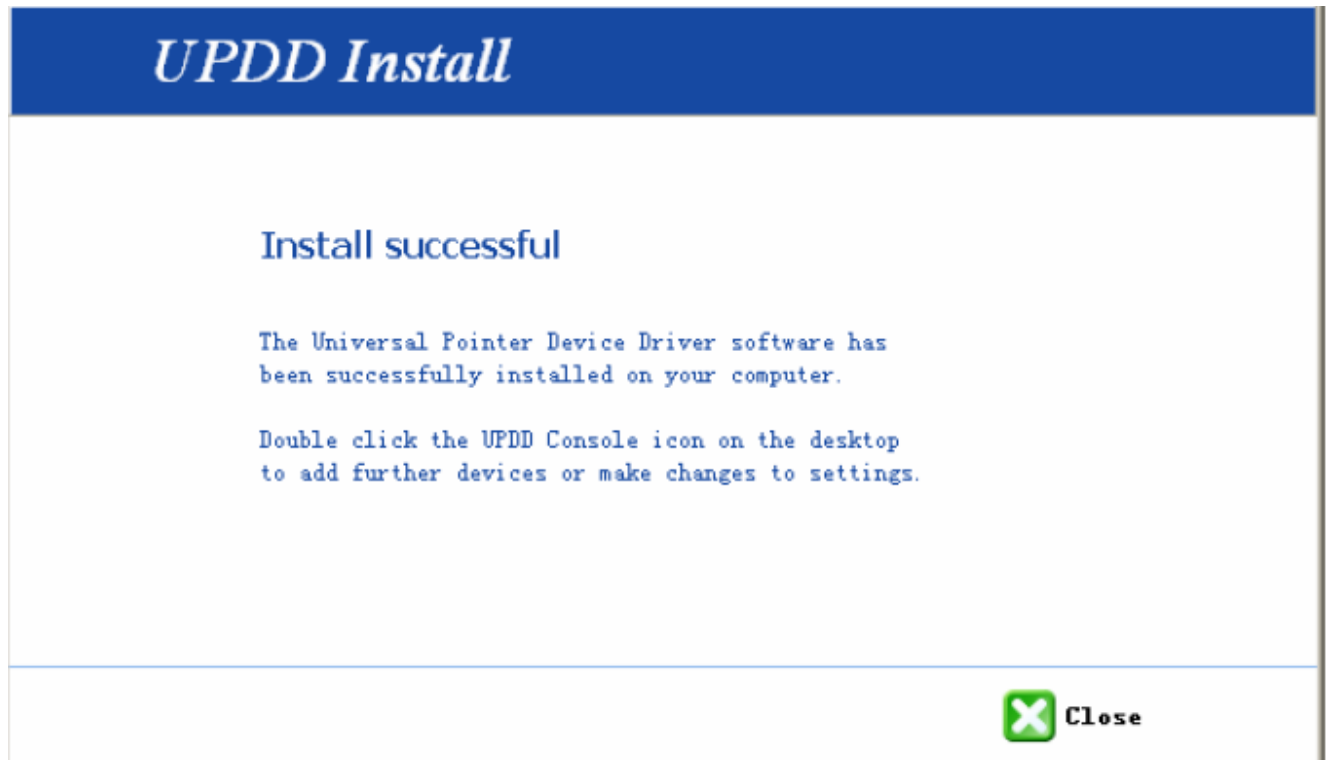

## 2.6.2 Calibration

Click  at the right side in the down corner of the Desk-Top, then choose “calibrate” in the pop-out of the menu, and choose the “RS232” or “USB” at the submenu, as follow:

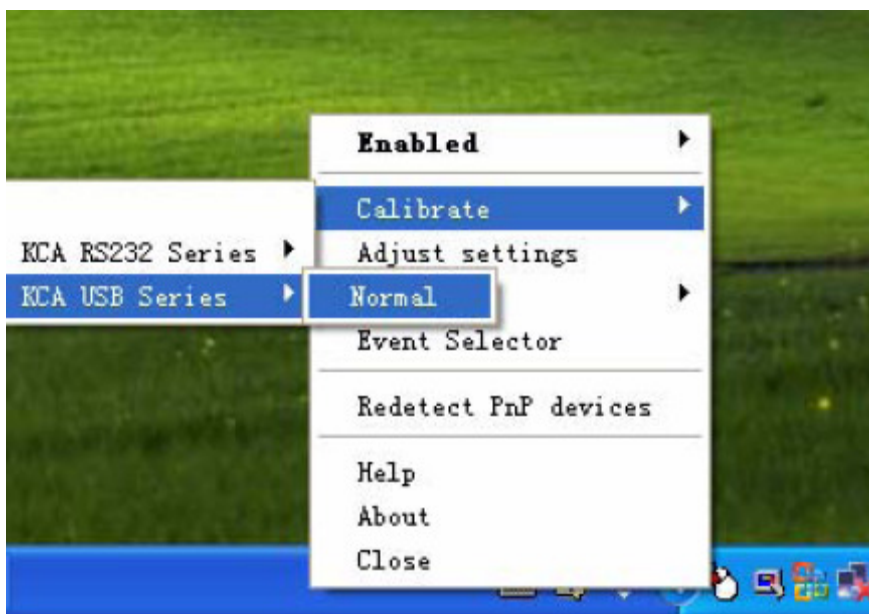

Windows will pop-out the calibration interface, then click “+” with finger one by one, as follow:

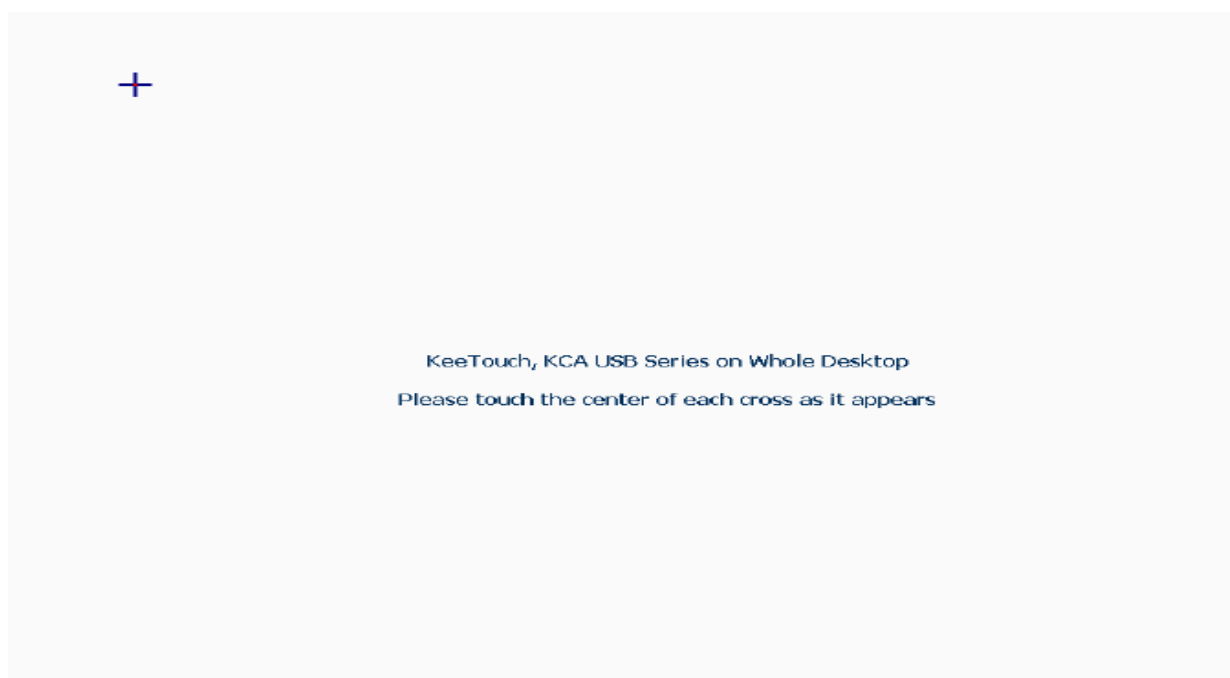

After clicking the “+” on by one, the calibration is completed.

# Appendix A

## TECHNICAL SPECIFICATIONS

### ◇ Specification

<b>Model No.</b>	KOT-0121US-SA6BP	
<b>Series</b>	OT, Dust-proof	
<b>Structure</b>	Metal-cased Openframe and Black medal Dust-proof Front Bezel	
<b>LCD Type</b>	Active matrix TFT-LCD	
<b>Display Size</b>	12.1 " (diagonal)	
<b>Active Area</b>	246mm×184.5mm	
<b>Suggested Resolution</b>	800×600	
<b>Support Colors</b>	262K	
<b>Brightness(Typ.)</b>	Pure LCD Panel	370cd/m <sup>2</sup>
	With SAW Glass Sensor	333cd/m <sup>2</sup>
<b>Response Time(Typ.)</b>	45ms	
<b>Viewing Angle (Typ.at CR&gt;10)</b>	Horizontal(left/right)	70°/70°
	Vertical(up/down)	50°/60°
<b>Contrast Ratio(Typ.)</b>	450:1	
<b>Video Input</b>	Analog RGB	
<b>Signal Input</b>	H/V Separate Sync. (TTL)	
<b>Video Signal Input Connector</b>	Mini D-Sub 15-pin VGA	
<b>Frequency (H/V)</b>	30~80KHz / 60~75Hz	
<b>Power Supply</b>	Type: External brick	
	Input (line) voltage: 100-240 VAC, 50-60 Hz Output voltage/current: 12 volts at 4 amps max	
<b>Environment</b>	Operating Temp.	0~50°C
	Storage Temp.	-20~60°C
	Operating RH:	20%~80%
	Storage RH:	10%~90%
<b>MTBF</b>	50,000 Hours	
<b>LCD Back light Life(Typ.)</b>	50,000 Hours	
<b>Weight (N.W/G.W)</b>	4.3Kg /5.8 Kg (Approx.)	
<b>Power Consumption</b>	25W Max.	
<b>Mount Interface</b>	1)VESA 75mm and 100mm	

	2)Mount bracket, horizontal or vertical (Standard mount brackets are supplied)	
<b>OSD Control</b>	Buttons	AUTO,+,POWER,-,MENU
	Function	Brightness, Contrast Ratio, Auto-adjust, Phase, Clock, H/V Location, Languages, Function, Reset
<b>Touch screen Type</b>	12.1" SAW 6MM thickness of touch screen sensor; (Available Options: Anti-glare/Tempered)	
<b>Touch System Interface</b>	USB and RS232	
<b>Certificates</b>	ETL ,FCC,CE,RoHS	

### ✧ Mechanical Drawing

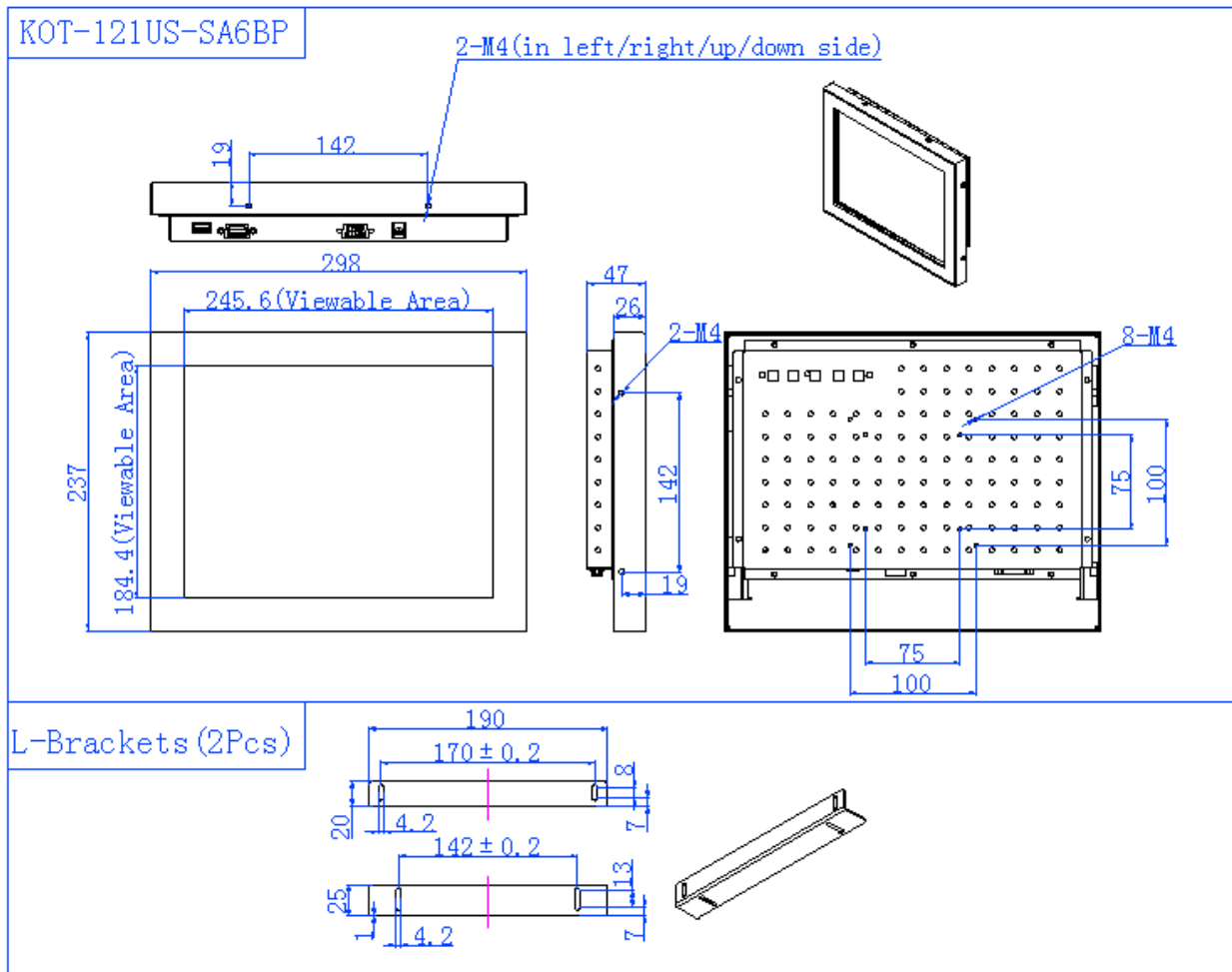

## ✧ Accessories

**Power Cable:** A North American power cable or an European power cable is included according to the end user' s area.

**Power Supply Brick:**A power supply brick is included.

**Touch/Video Cables:** Detachable serial or USB touch cable, and video cables are included

**L-brackets:** Two standard L-brackets are included.

# Appendix **B**

## ✧ Typical Application

Gaming/Casino Systems  
Outdoor and indoor Kiosks  
Entertainment  
Transport and Ticketing  
Hospitality  
Banking  
Customized Solutions

## **How to contact us**

[www.keetouch.com](http://www.keetouch.com)

*Add: 1-4th Floor, Building 9  
Luck-King Science & Industry Park  
Gongyedong Road, Longhua  
Baoan, Shenzhen 518109, P.R.China*

*Tel: +86-755-82599299*

*Fax: +86-755-82599968*

*Sales & Marketing: [sales@keetouch.com](mailto:sales@keetouch.com)*

*Technical Support: [support@keetouch.com](mailto:support@keetouch.com)*

