

# **17" LCD Open frame SAW Touch Monitor (the Primary Type)**

## **User Guide**

**Rev2.0**

**KOT-0170US-SA4B**



Shenzhen K&JAD Technology Co., Ltd

**[www.keetouch.com](http://www.keetouch.com)**

Dec. 2010

# Table of Contents

## Chapter 1

### Introduction

1.1 Product Description .....	3
1.2 Precautions .....	3
1.3 About the Product .....	3

## Chapter 2

### Installation and Setup

2.1 Unpacking Your Touchmonitor .....	4
2.2 Product Overview .....	5
2.3 Attaching the L-bracket .....	5
2.4 VESA Mounting Interface .....	6
2.5 Interface Connection .....	7
2.6 Installing the Driver Software and Calibration .....	8
2.6.1 Installing the Driver Software .....	8
2.6.2 Calibration .....	9

## Chapter 3

### Operation

3.1 About Touchmonitor Adjustments .....	11
3.1.1 Rear Panel Controls .....	11
3.2 Controls and Adjustment .....	12
3.2.1 On Screen Display (OSD) Menu Functions .....	12
3.2.2 Power Management System .....	12

## Chapter 4

### Troubleshooting

Solutions to Common Problems .....	13
------------------------------------	----

## Appendix A

Native Resolution .....	14
-------------------------	----

## Appendix B

Touchmonitor Safety .....	15
Care and Handling of Your Touchmonitor .....	15

## Appendix C

Specification .....	16
Mechanical Dimensions .....	17
Typical Application .....	18

How to contact us .....	18
-------------------------	----

# Chapter 1

## INTRODUCTION

### 1.1 Product Description

Keetouch's 17" open frame LCD touchmonitors have a long-lasting product cycle because the enclosure is controlled by Keetouch's specifications. Future panel improvements are therefore possible without external changes. The KOT-0170US-SA4B integrate with the Keetouch's SAW technology touchscreen.

### 1.2 Precautions

Follow all warnings, precautions and maintenance as recommended in this user's guide to maximize the life of your unit. See Appendix B for more information on touchmonitor safety.

### 1.3 About the Product

Your LCD openframe touchmonitor is a 17" SXGA TFT color display with the following features:

- Long lasting product cycle-enclosure controlled by Keetouch specifications
- Future generation panels phased-in without external changes
- High quality panel with high brightness,high contrast ratio and broad viewing angle
- Multiple mounting options including VESA mount, horizontal or vertical bracket-mount
- Keetouch's SAW technology on pure glass for the ultimate in image quality
- Finger or gloved hand operation
- Dual USB/Serial touch interface port
- Worldwide agency approvals

For full Product Specifications refer to Appendix C.

# Chapter 2

## **INSTALLATION AND SETUP**

This chapter discusses how to install your LCD touchmonitor and how to install the driver software.

### 2.1 Unpacking Your Touchmonitor

Check that the following 9 items are present and in good condition:

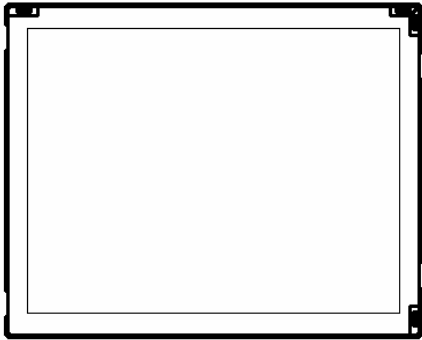

One Touchmonitor

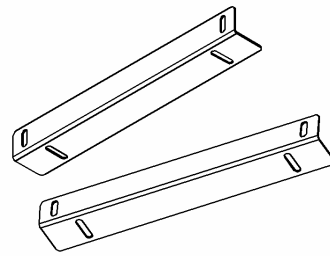

Two L-brackets

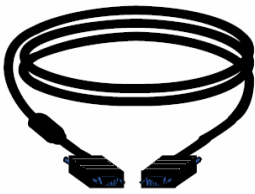

One Video cable

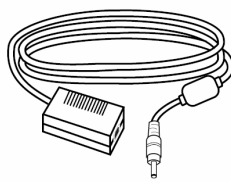

One Brick power supply

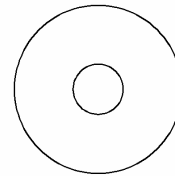

One Driver software CD

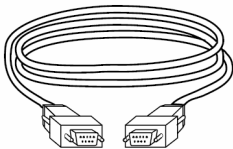

One Serial cable

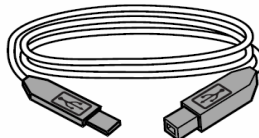

One USB cable



Eight M4 Screws and Washers

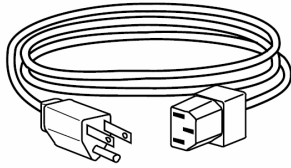

One Power cable US/Canada

OR

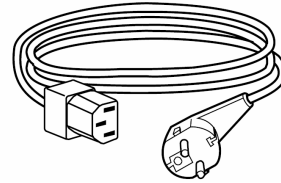

One European power cable

## 2.2 Product Overview

**Main Unit**

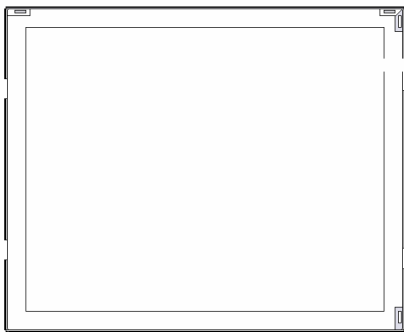

**Rear View**

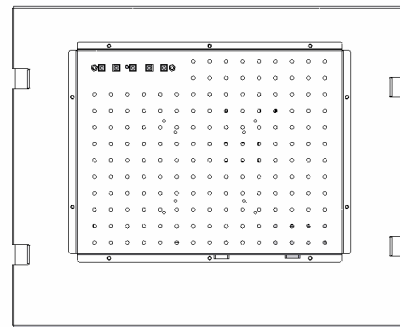

**Side View**



**Bottom View**

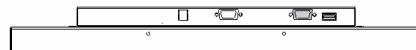

## 2.3 Attaching the L-Brackets

**NOTE: You will need a screwdriver to attach the L-brackets.**

To attach the L-brackets:

- 1 Lay the monitor face down.
- 2 Place the long end of the L-bracket against the side of touchmonitor. Line up the two holes of the L-bracket with the two holes of the touchmonitor.
- 3 Place two M4 screws in the holes and with the screwdriver, screw them in to secure the bracket.
- 4 Repeat steps 2 and 3 to attach the other L-bracket to the other side of the touchmonitor.

**NOTE: The way to attach the L-brackets has two options, See the illustration below:**

**Option 1 (L-brackets to the left and right sides)**

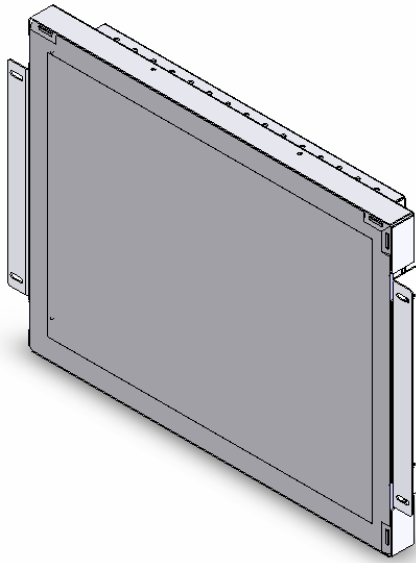

**Option 2 (L-brackets to the up and down sides)**

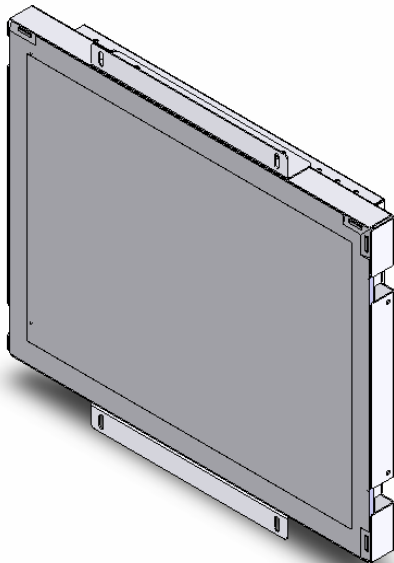

## 2.4 VESA Mounting Interface

Your touchmonitor conforms to the VESA Flat Panel Monitor Physical Mounting Interface (FPMPMITM) Standard which defines a physical mounting interface for flat panel monitors, and corresponding standards for flat panel monitor mounting devices, such as wall and table arms.

Your monitor has standard VESA mounting holes on the rear of the unit. The holes are spaced at 75mm and 100mm standard.

**NOTE: Do not penetrate the M4 screw into the monitor more than 5mm.**

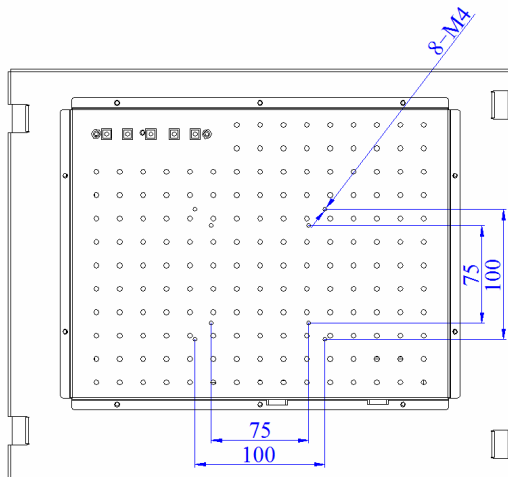

## 2.5 Interface Connection

**Note: Before connecting the cables to your touchmonitor and PC, be sure that the computer and touchmonitor are turned off.**

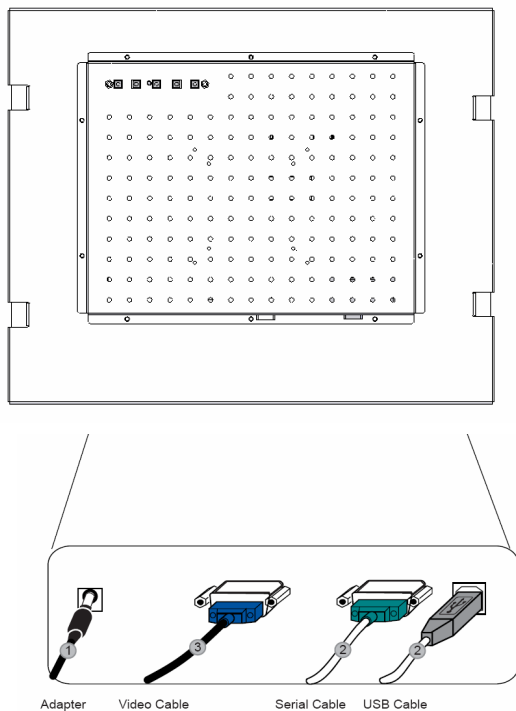

1. Connect one end of either the **serial (RS232) cable** or the **USB cable**(but not both) to the rear side of the computer and the other end to the LCD monitor. Tighten by turning the two thumb screws clockwise to ensure proper grounding ( USB cable does not have thumb screws).
2. Connect one end of the **video cable** to the rear side of computer and the other to the LCD monitor. Tighten by turning the two thumb screws clockwise to ensure proper grounding.
3. Connect one end of the **power adapter** to the monitor and the other end to the connector of the power cord.
4. Press the **power button** on the rear panel to turn the monitor power on.

**NOTE:** The touchmonitor should be integrated according to the above process, if not may result in the touchmonitor working abnormally.

## 2.6 Installing the Driver Software and Calibration

Keetouch TouchSystems provides driver software that allows your touchmonitor to work with your computer. Drivers are located on the enclosed CD-ROM for the following operating systems:

- Windows XP
- Windows 2000
- Mac
- Linux

The latest versions of drivers and driver information for other operating systems are available on the Keetouch TouchSystems web site at [www.Keetouchtouch.com](http://www.Keetouchtouch.com).

Your Keetouch touchmonitor is Plug-and-Play compliant. Information on the video capabilities of your touchmonitor is sent to your video display adapter when Windows starts. If Windows detects your touchmonitor, follow the instructions on the screen to install a generic Plug-and-Play monitor.

### 2.6.1 Installing the Driver Software

double click the file of “Setup.exe” in the folder , the Windows will flip Dialog Box as follow:

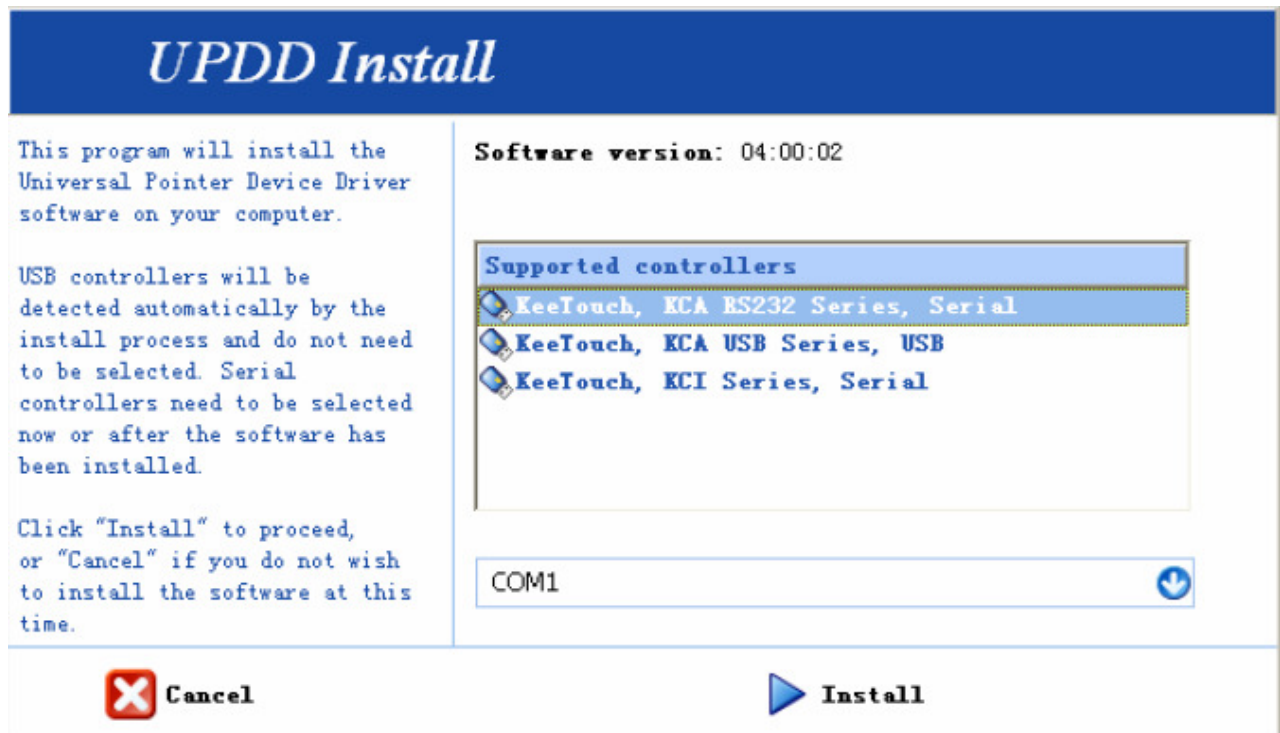

**NOTE:**Your touchmonitor have dual USB and Serial(RS232) touch interface port, Depending upon whether you connected the USB communication cable or the Serial(RS232) communication cable, you should install only the USB driver or the Serial(RS232) driver. Install the USB driver, please chose the “KeeTouch, KCA USB Series, USB”;Install the Serial(RS232) driver, please chose “theKeeTouch,KCA RS232 Series,Serial”.



After selecting the proper interface, click the Install button to start installing the driver as following.

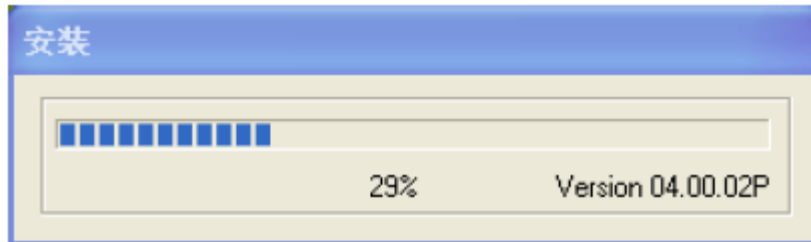

Installation successfully as following:

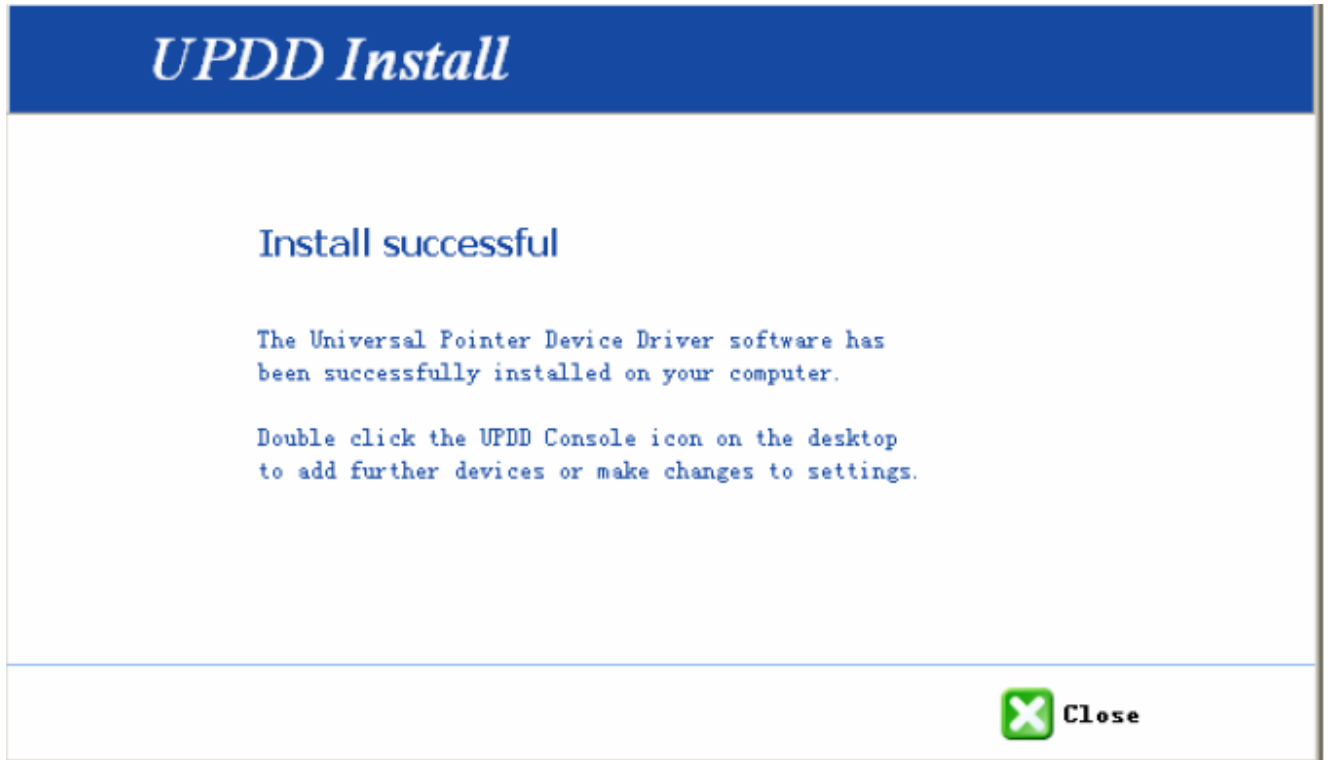

## 2.6.2 Calibration

Click  at the right side in the down corner of the Desk-Top, then choose “calibrate” in the pop-out of the menu, and choose the “RS232” or “USB” at the submenu, as follow:

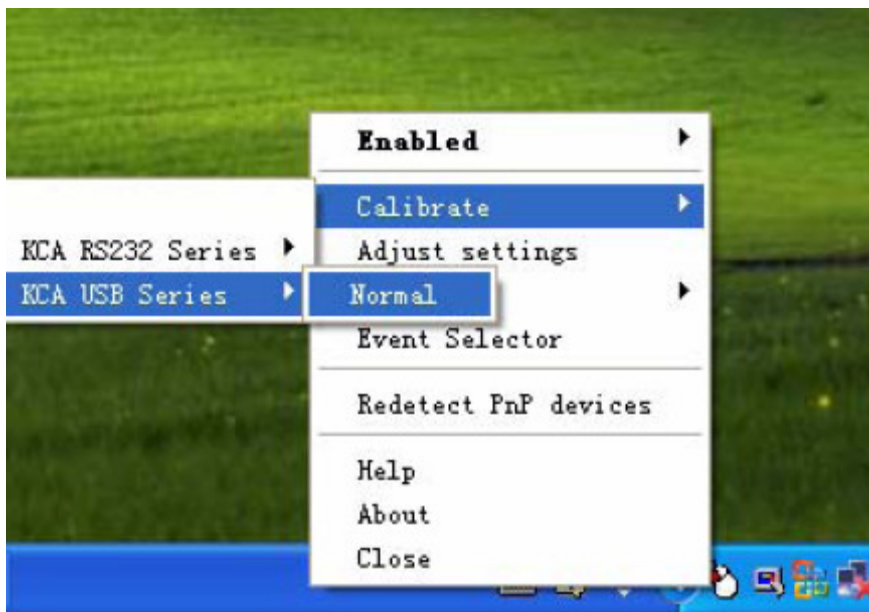

Windows will pop-out the calibration interface, then click “+” with finger one by one, as follow:

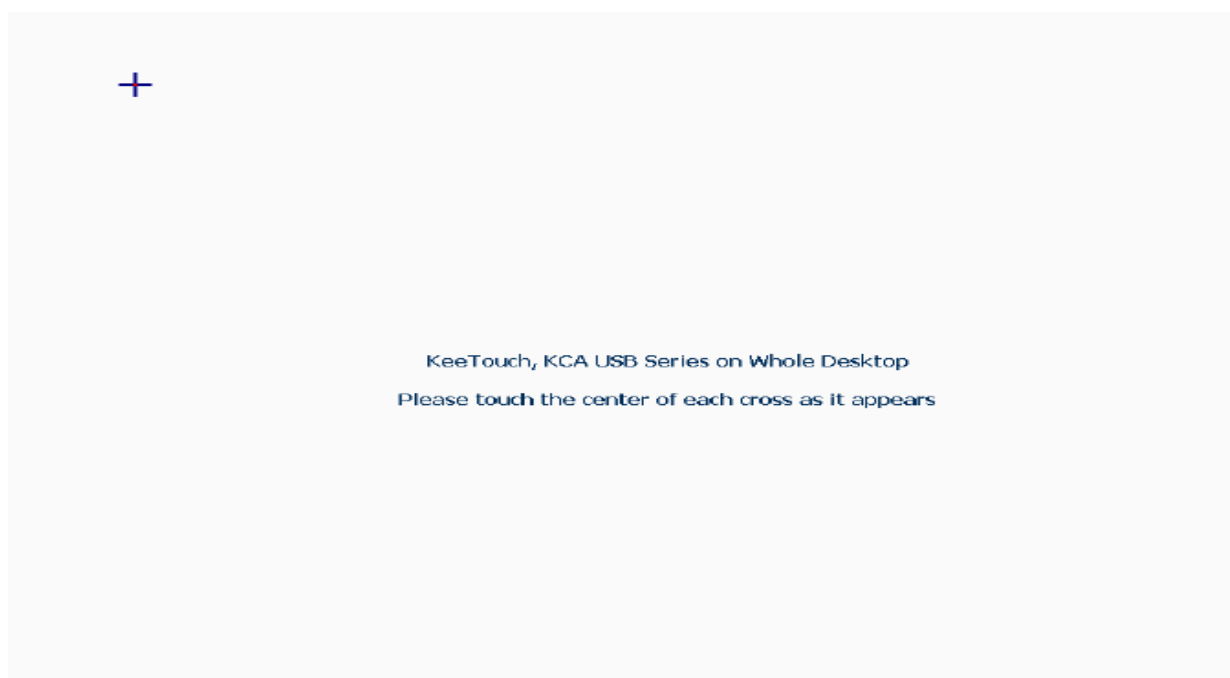

After clicking the “+” on by one, the calibration is completed.

# Chapter 3

## OPERATION

### 3.1 About Touchmonitor Adjustments

Your touchmonitor will not likely require adjustment. Variations in video output and application may require adjustments to your touchmonitor to optimize the quality of the display. For best performance, your touchmonitor should be operating in native resolution, that is 1280×1024 at 80k-75 Hz. Use the Display control panel in Windows to choose 1280×1024 resolution. Operating in other resolutions will degrade video performance. For further information, please refer to Appendix A.

All control adjustments are automatically memorized. This feature saves you from having to reset your choices every time you unplug or power your touchmonitor off and on. If there is a power failure, your touchmonitor settings will not default to the factory specifications

#### 3.1.1 Rear Panel Controls

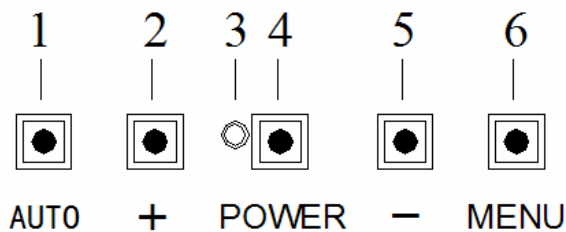

#### Control Function

- |   |                  |   |
|---|------------------|---|
| 1 | <b>AUTO</b>      | adjust to an optimum image automatically  |
| 2 | <b>+</b>         | 1) Enter brightness adjustment.<br>2) Increase value of the adjustment item.<br>3) Select item counter-clockwise. |
| 3 | <b>Power LED</b> |   |
| 4 | <b>Power</b>     | Switches the power of the monitor   |
| 5 | <b>-</b>         | 1) Enter brightness adjustment.   |

2)Decrease value of the adjustment item.

3)Select item clockwise.

6 **Menu** Display/exits the On Screen Display (OSD) menus

## 3.2 Controls and Adjustment

### 3.2.1 On Screen Display (OSD) Menu Functions

To Display and Select the OSD Functions:

1 Press the **Menu** key to activate the OSD menu.

2 Use **+** or **-** to move through the menu. Press the **Menu** key, the parameter will be highlighted when selected.

3 To quit the OSD screen at any time during the operation, press the **AUTO** key.

**NOTE:If no keys are pressed for a short time period, the OSD automatically disappears.**

### 3.2.2 Power Management System

The monitor is equipped with the power management function which automatically reduces the power consumption when not in use.

<b>Power</b>	<b>Mode Consumption</b>
On	<40W
Sleep	<4W
Off	<2W

We recommend switching the monitor off when it is not in use for a long time.

**NOTE: The monitor automatically goes through the Power Management System (PMS) steps when it is idle. To activate the monitor, press any key on the keyboard or move the mouse.**

# Chapter 4

## TROUBLESHOOTING

If you are experiencing trouble with your touchmonitor, refer to the following table. If the problem persists, please contact your local dealer or our service center.

### Solutions to Common Problems

<b>Problem</b>	<b>Suggestion(s)</b>
The monitor does not respond after you turn on the system	1)Check that the monitor's Power Switch is on. 2)Turn off the power and check the monitor's power cord and signal cable for proper connection.
Characters on the screen are dim	Refer to the About Touchmonitor Adjustments section to adjust the brightness.
The screen is blank	1)During operation, the monitor screen may automatically turn off as a result of the Power Saving feature. Press any key to see if the screen reappears. 2) Refer to the About Touchmonitor Adjustments section to adjust the brightness.
Screen flashes when initialized	Turn the monitor off then turn it on again.
"Out of Range" display	Check to see if the resolution of your computer is higher than that of the LCD display.Reconfigure the resolution of your computer to make it less than or equal to 1024×768. See Appendix A for more information on resolution.
Touch doesn't work	Make sure the touch cable is securely attached at both ends.

# Appendix A

## NATIVE RESOLUTION

The native resolution of a monitor is the resolution level at which the LCD panel is designed to perform best. For the LCD touchmonitor, the native resolution is 1280 x 1024 for the 17 inch size. In almost all cases, screen images look best when viewed at their native resolution. You can lower the resolution setting of a monitor but not increase it.

Input Video	17" LCD
640 x 480 (VGA)	Transforms input format to 1280 x 1024
800 x 600 (SVGA)	Transforms input format to 1280 x 1024
1024 x 768 (XGA)	Transforms input format to 1280 x 1024
1280 x 1024(SXGA)	Displays in Native Resolution

The native resolution of an LCD is the actual number of pixels horizontally in the LCD by the number of pixels vertically in the LCD. LCD resolution is usually represented by the following symbols:

VGA	640 x 480
SVGA	800 x 600
XGA	1024 x 768
SXGA	1280 x 1024
UXGA	1600 x 1200

As an example, a SXGA resolution LCD panel has 1280 pixels horizontally by 1024 pixels vertically. Input video is also represented by the same terms. SXGA input video has a format of 1280 pixels horizontally by 1024 pixels vertically. When the input pixels contained in the video input format match the native resolution of the panel, there is a one to one correspondence of mapping of input video pixels to LCD pixels. As an example, the pixel in column 45 and row 26 of the input video is in column 45 and row 26 of the LCD. For the case when the input video is at a lower resolution than the native resolution of the LCD, the direct correspondence between the video pixels and the LCD pixels is lost. The LCD controller can compute the correspondence between video pixels and LCD pixels using algorithms contained on its controller. The accuracy of the algorithms determines the fidelity of conversion of video pixels to LCD pixels. Poor fidelity conversion can result in artifacts in the LCD displayed image such as varying width characters.

# Appendix **B**

## **TOUCHMONITOR SAFETY**

This manual contains information that is important for the proper setup and maintenance of your touchmonitor. Before setting up and powering on your new touchmonitor, read through this manual, especially Chapter 2 (Installation), and Chapter 3 (Operation).

- 1 To reduce the risk of electric shock, follow all safety notices and never open the touchmonitor case.
- 2 Turn off the product before cleaning.
- 3 The socket-outlet shall be installed near the equipment and shall be easily accessible.
- 4 The slots located on the sides and top of the touchmonitor case are for ventilation. Do not block or insert anything inside the ventilation slots.
- 5 It is important that your touchmonitor remains dry. Do not pour liquid into or onto your touchmonitor. If your touchmonitor becomes wet do not attempt to repair it yourself.

## **Care and Handling of Your Touchmonitor**

The following tips will help keep your touchmonitor functioning at the optimal level.

- To avoid risk of electric shock, do not disassemble the brick supply or display unit cabinet. The unit is not user serviceable. Remember to unplug the display unit from the power outlet before cleaning.
- Do not use alcohol (methyl, ethyl or isopropyl) or any strong dissolvent. Do not use thinner or benzene, abrasive cleaners or compressed air.
- To clean the display unit cabinet, use a cloth lightly dampened with a mild detergent.
- Avoid getting liquids inside your touchmonitor. If liquid does get inside, have a qualified service technician check it before you power it on again.
- Do not wipe the screen with a cloth or sponge that could scratch the surface.
- To clean the touchscreen, use window or glass cleaner. Put the cleaner on the rag and wipe the touchscreen. Never apply the cleaner directly on the touchscreen.

## Appendix

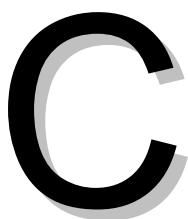

**TECHNICAL SPECIFICATIONS**

<b>Model No.</b>	KOT-0170US-SA4B	
<b>Series</b>	OT	
<b>Structure</b>	Metal-cased open frame	
<b>LCD Type</b>	17 " Active matrix TFT-LCD	
<b>Active Area</b>	13.3 " (338mm)×10.6 " (270mm)	
<b>Monitor Dimensions</b>	<b>Width:</b> 388mm <b>Width with bracket:</b> 428mm <b>Height:</b> 316mm <b>Height with bracket:</b> 356mm <b>Depth:</b> 47mm	
<b>Suggested Resolution</b>	1280×1024	
<b>Supported Resolution</b>	1280×1024 at 60,75 Hz; 1024×768 at 60,70,75 Hz; 800×600 at 60,72,75 Hz; 640×480 at 60,72,75 Hz; 640×400 at 70 Hz	
<b>Support Colors</b>	16.2M	
<b>Brightness(Typ.)</b>	Pure LCD Panel	300cd/m <sup>2</sup>
	With SAW Glass Sensor	275cd/m <sup>2</sup>
<b>Response Time(Typ.)</b>	8ms	
<b>Viewing Angle (Typ.at CR&gt;10)</b>	Horizontal(left/right)	75°/75°
	Vertical(up/down)	75°/60°
<b>Contrast Ratio(Typ.)</b>	700:1	
<b>Video Input</b>	Analog RGB	
<b>Signal Input</b>	H/V Separate Sync. (TTL)	
<b>Video Signal Input Connector</b>	Mini D-Sub 15-pin VGA	
<b>Frequency (H/V)</b>	30~80KHz / 60~75Hz	
<b>Power Supply</b>	Type: External brick Input (line) voltage: 100-240 VAC, 50-60 Hz Output voltage/current: 12 volts at 4 amps max	
<b>Environment</b>	Operating Temp.	0~50°C
	Storage Temp.	-20~60°C
	Operating RH:	20%~80%



	Storage RH:	10%~90%
<b>MTBF</b>	50,000 Hours	
<b>LCD Back light Life(Typ.)</b>	50,000 Hours	
<b>Weight (N.W/G.W)</b>	5Kg / 7.8Kg	
<b>Power Consumption</b>	40W Max.	
<b>Mount Interface</b>	1)VESA 75mm and 100mm 2)Mount bracket, horizontal or vertical (Standard mount brackets are supplied)	
<b>OSD Control</b>	Buttons	AUTO,+,POWER,-,MENU
	Function	Brightness, Contrast Ratio, Auto-adjust, Phase, Clock, H/V Location, Languages, Function, Reset
<b>Touch screen Type</b>	KAL-0170-4B: 17" SAW 4MM thickness of touch screen sensor (Available Options: Thickness/Anti-glare/Tempered)	
<b>Touch System Interface</b>	Having USB and serial interface	
<b>Touch Response time</b>	9ms	
<b>Agency Approval</b>	ETL, FCC, CE, RoHS	
<b>Regular Warranty</b>	5 years for SAW Sensor; 3 years for controller; 1 year for LCD	

**NOTE:**The display SPEC. will change follow the relevant LCD panel brand and model

## ◆ Mechanical Dimensions

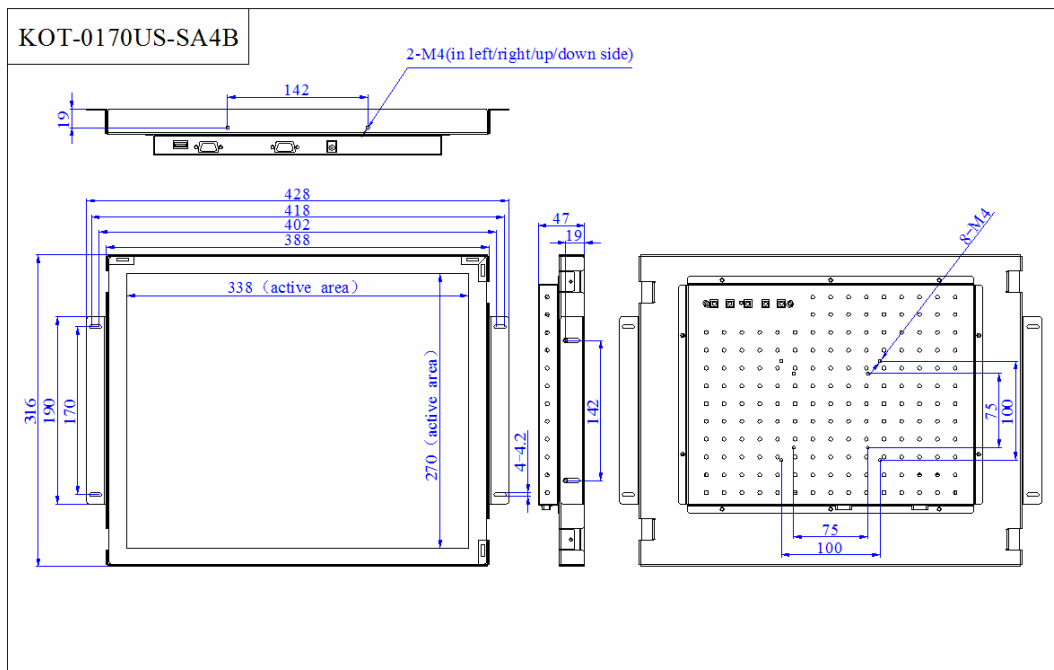

◆ Typical Application

Gaming/Casino Systems  
Outdoor and indoor Kiosks  
Entertainment  
Transport and Ticketing  
Hospitality  
Banking  
Customised Solutions

 **How to contact us**

[www.Keetouchtouch.com](http://www.Keetouchtouch.com)

*Add: 1-4th Floor, Building 9  
Luck-King Science & Intustry Park  
Gongyedong Road, Longhua  
Baoan, Shenzhen 518109, P.R.China*

*Tel: +86-755-82599797*

*Fax: +86-755-82599968*

*Sales & Marketing: [sales@keetouch.com](mailto:sales@keetouch.com)*

*Technical Support: [support@keetouch.com](mailto:support@keetouch.com)*

